

PTZ  
Network Video Camera  
NEIUS & NEIUS PLATINUM  
Series

**User Manual**

Thank you for selecting our products. Please read the User Manual carefully before using this product. This User Manual will provide you with correct instructions for operation and operation.

## Statement

- The Company has the right to update the contents of this Manual according to the enhancements and changes of product functions, and periodically improve the software and hardware products described in this Manual. Updated information may be reflected in the latest version of this Manual without prior notice.
- Product parameters may change because of continuously using new technologies without prior notice.
- This Manual is only used for providing reference and guidance for customers. It is not guaranteed to be completely consistent with the actual product, and the actual product may prevail during practical application.
- The information on the texts, forms and pictures in this Manual are protected by relevant national laws, and it shall not be used without permission.
- All the copyright and final interpretation right of this manual belong to our company.

• Contents

<b>1</b>	<b>PRECAUTIONS.....</b>	<b>6</b>
<b>2</b>	<b>PRODUCT OVERVIEW.....</b>	<b>10</b>
2.1	MAIN FUNCTIONS AND CHARACTERISTICS.....	11
2.1.1	Basic functions .....	11
2.1.2	Remote access and transmission functions .....	12
2.2	MAIN APPLICATION OCCASIONS.....	12
<b>3</b>	<b>INSTALLATION INSTRUCTIONS.....</b>	<b>14</b>
3.1	PREPARATION FOR INSTALLATION .....	14
3.1.1	Basic requirements .....	14
3.1.2	Common installation tools:.....	14
3.1.3	Check the strength of the construction of installation space and installation site .....	15
3.1.4	Please keep the original packaging materials of network camera properly .....	15
3.2	INSTALLATION METHODS OF DOME CAMERAS .....	15
3.3	ILLUSTRATIONS OF DOME CAMERA AND INTERFACE DIMENSIONS .....	18
3.4	INSTALLATION STEPS (TAKE WALL-MOUNTED INSTALLATION AS AN EXAMPLE).....	19
3.5	INSTALLATION PROCEDURE THERMAL BI-SPECTRUM AI PTZ CAMERA (TAKE THE WALL MOUNTED AS AN EXAMPLE ONLY) .....	21
3.6	ILLUSTRATION OF EXTERNAL WIRING .....	23
<b>4</b>	<b>DESCRIPTIONS OF FUNCTIONS.....</b>	<b>26</b>
4.1	BASIC FUNCTION DESCRIPTION .....	26
<b>5</b>	<b>WEB CLIENT .....</b>	<b>28</b>
5.1	OPERATING ENVIRONMENT .....	28
5.2	INSTRUCTIONS FOR EMBEDDED WEB SERVER .....	28
5.3	LOGIN DEVICE .....	29
5.3.1	Equipment activation .....	29
5.3.2	IE login interface .....	30
5.4	AUDIOS AND VIDEOS PREVIEW .....	32
5.4.1	Button of video preview interface .....	32
5.4.2	PTZ control .....	34
5.4.3	Preset .....	37
5.4.4	VCA Action .....	38
5.4.5	Image .....	39
5.4.6	Quick Scene.....	39
5.5	PLAYBACK.....	40
5.5.1	Refer to the front-end video file .....	41
5.6	LOG.....	43
5.7	CONFIGURATION .....	44
5.7.1	Basic Set .....	45
5.8	AUDIO VIDEO SET .....	49
5.8.1	Stream.....	49
5.8.2	Audio.....	52
5.8.3	Image Setting .....	53



5.8.4	OSD .....	60
5.9	DOME SET .....	64
5.9.1	Basic Set .....	64
5.9.2	Motion Set .....	68
5.9.3	Remove Config .....	72
5.10	NETWORK.....	73
5.10.1	Basic Set .....	73
5.10.2	Advanced Set .....	77
5.11	EVENT SCHEDULE .....	84
5.11.1	Event Management.....	84
5.12	SMART SURVEILLANCE ( VCA ) .....	90
5.12.1	Create Rule.....	90
5.12.2	Shield Area .....	108
5.12.3	Cruise Set .....	109
5.12.4	Advance Params.....	110
5.12.5	Intelligent Retrieval.....	111
5.12.6	Online VCA Log .....	112
5.13	SMART SURVEILLANCE ( THERMAL BI-SPECTRUM AI PTZ CAMERA PART ) .....	112
5.13.1	Algorithm configuration.....	113
5.13.2	Create Rule.....	114
5.13.3	Shield Area .....	124
5.13.4	Cruise Set .....	127
5.13.5	Advance Params.....	127
5.13.6	VCA Report.....	127
5.13.7	Online VCA log .....	128
5.14	CAPTURE FACIAL IMAGES .....	128
5.14.1	Face Configuration .....	128
5.14.2	Snapshot parameters.....	132
5.14.3	Cruise Set .....	135
5.14.4	Advance Params.....	136
5.15	STORAGE .....	136
5.15.1	Schedule Recording.....	136
5.15.2	Picture setting.....	138
5.15.3	Disk Management.....	139
5.15.4	FTP .....	140
5.16	SYSTEM.....	143
5.16.1	System.....	143
5.16.2	Users .....	146
5.16.3	Maintenance.....	148
5.16.4	Local PC Settings .....	151
<b>6</b>	<b>  SIMPLE TROUBLESHOOTING .....</b>	<b>152</b>
<b>7</b>	<b>  AFTER-SALES SERVICES .....</b>	<b>154</b>
<b>8</b>	<b>  APPENDIX I LIGHTNING PROTECTION AND SURGE PROTECTION .....</b>	<b>155</b>



# 1 Precautions

The purpose of this Manual is to ensure that users can operate the products properly, thus avoiding danger or property damage. Please read this Manual carefully and keep it properly for future reference before using the products.

As shown below, the precautionary measures are divided into two parts: "Warning" and "Note":

**Warning: ignoring the warning may result in death or severe injury.**

**Attention: ignoring the precautions may result in injury or property damage.**

	
Warning Alert users to prevent the potential danger of death or serious injury	Note Alert users to prevent the potential danger of injury or property damage



## **Warning:**

1. Input voltage should meet both the SELV (Safety Extra Low Voltage)
2. Contact the distributor for abnormal operation. Do not disassemble or modify the devices in any way.
3. Moisture must be avoided for indoor devices in case of fire and electric shock.
4. Install the equipment on the ceiling to ensure that it can withstand at least 4 times the weight of the equipment.
5. Do not look directly at the concentrated laser beam.

6. The camera should be installed by professional personnel in the way complying with local laws and regulations.

7. The easy-to-use power failure protection device should be installed in building installation wiring.

8. Don't disassemble internal parts of the camera privately. No internal part can be privately repaired by the user. Repair work can only be performed by maintenance staff authorized by our company and we will not be responsible for any problem caused by unauthorized modification or maintenance of the product.



**Note:**

- 1. Please check whether the power supply is correct before camera running.
- 2. Please do not get the product to drop down to the ground or be strongly knocked.
- 3. Please don't directly touch the glass and spherical outer cover in front of the lens. To clean it, you may wipe the surface with microfiber cleaning cloth, such as glasses cloth. Don't wipe it too hard or wipe with water.
- 4. Don't focus at strong light (such as light, sunlight, laser, etc.); otherwise, over-bright or light pulling phenomenon (not the fault of the camera) may occur and the service life of the image sensor may also be shortened.
- 5. Avoid putting it at places damp, dusty, extremely hot, extremely cold or with strong electromagnetic radiation.
- 6. It is strongly recommended to transport the camera with the original package.
- 7. Long-term high-speed cruising of the camera may lead to ring sliding and aging of the synchronous belt, thus affecting the machine's service life.

- 8. Wipers will automatically enter the protection state to prevent equipment damage when it is at 0°C or below.
- 9. Dong use the wiper when it is not rainy. Otherwise, glass wearing or damage of the wiper may be caused.
- 10. The bending radius of optical fiber cable should not be less than 20mm.
- 11. The working bid documents of the laser is -10°C ~ +40°C. Beyond this range, the laser will shut down automatically.
- 12. For details about functions of the camera, please refer to the Help file at the right upper corner of the IE browser.
- 13. The analog video port is for rapid debugging and is nor formal video output port.
- 14. The running speed of the dome camera will be adjusted automatically based on the external enviroment and slightly decrease in the ulta-low temperature (-under 20°C).
- 15. Please use the product under the requirement of working environment.

	Infrared dome camera	High speed dome camera	Super Starlight IR Laser AEW AI PTZ camera	Thermal&Optical Bi-spectrum AI PTZ Camera
Ambient temperature	-40°C ~ +70°C	-40°C ~ +70°C	-40°C ~ +70°C	-40°C ~ +70°C
Ambient humidity	<95%(no condensation)	<95%(no condensation)	<95%( no condensation)	<95%( no condensation)
Atmosphe	86~106KPa	86~106KPa	86~106KPa	86~106KPa

ric pressure				
Power supply	AC 24V/3.0A	AC 24V/2.0A	AC24V/8A	AC24V/8A

Attention: make sure that the outdoor installation of the dome camera meets the waterproof requirements

➤ 16. Illustration of dome camera installation environment

To get rid of the vapor in the high-speed dome camera cover affecting the video effect and the life of electrical parts, please assemble the ball cover under the condition of ventilated and dry environment, and ensure that the screws of the dome camera are tightened.

## 2 Product overview

This series of products include high-definition network high speed dome camera (hereinafter referred to as high speed dome camera) and high-definition infrared network high-speed dome camera (hereinafter referred to as infrared dome camera), hyper-star optical warning camera and hyper-star thermal warning camera (hereinafter referred to as Thermal & Optical Bi-spectrum AI PTZ Camera), which are embedded digital monitoring product integrating traditional analog camera and network video server. They adopt embedded Linux operation system and advanced hardware platform, with high dispatching efficiency, code solidified in Flash or embedded multimedia card (eMMC), small volume, Low power consumption, high stability and reliability.

This series of dome camera adopt the integrated design, synchronous belt drive and precision stepping motor, which can run accurately and stably; different installation methods meet the needs of different occasions; with weather-wise outdoor design, double-layer shell structure, built-in fan and intelligent start; various monitoring methods, such as scanning, cruising, pattern path, etc., are flexible to be selected; integrated preset function ensures more powerful performance.

Special attention: the product function description in this manual is based on the infrared full-function dome camera, and the support functions of different models of dome cameras are subject to the actual functions of them.

## 2.1 Main functions and characteristics

### 2.1.1 Basic functions

- Heartbeat function: through the heartbeat mechanism, the management host can get the real-time operation status of the front-end network dome camera;
- PTZ control function: the RS485 interface (full-function dome camera) can support PTZ control and multiple decoder protocols and dome camera protocols;
- Alarming function: alarm input, alarm output, mobile detection alarm, video loss / blocking alarm, email alarm, alarm link output;
- Voice intercom: two-way voice intercom, one-way voice acquisition / broadcast;
- User management: multi user limits management modes. Senior administrator can create 4 sub-levels of users with each level of user's rights can be set and high system security;
- The embedded Web Server allows IE browser.
- Provide open SDK development package;
- Compression processing capacity;
- Support 25 frames per second (PAL system) / 30 frames per second (NTSC system)

- Support H.265 coding (full-function starlight dome camera), support changing not only code rate but also frame rate. When setting the video Fig. quality, it can also limit the video Fig. compression code stream;
- Support 5MP; 1440P; 3MP; 1080P; 960P; 720P; 4CIF (PAL: 704×576, NTSC: 704×480); DCIF (PAL: 528×384, NTSC: 528×320); 2CIF (PAL: 704×288, NTSC: 704×240); CIF (PAL: 352×288, NTSC: 352×240); (the specific resolution supported refer to the actual dome camera display)
- Excellent intelligent analysis and tracking function (full function dome camera).

### 2.1.2 Remote access and transmission functions

- A 10m / 100M adaptive Ethernet port is provided as standard;
- Support TCP / IP, HTTP, DHCP, DNS, RTSP, PPPOE and other protocols;
- Support ONVIF protocol, P2P (some dome cameras support, see dome camera configuration for details);
- Parameters, real-time video browsing, and viewing webcam status can be set through the application or IE browser. Alarm link can be achieved through network
- Remote management and maintenance can be achieved through remote network maintenance / upgrading.

## 2.2 Main application occasions

It is applicable to all kinds of occasions requiring remote network monitoring, such as:

- ATM, vault, teller and other monitoring occasions;



- Factory, workshop, warehouse and other monitoring occasions;
- Urban street monitoring, road condition information collection and other occasions
- Child-care centers, kindergartens, schools and families where need monitoring;
- Smart building, smart community and other management systems;
- Airport, railway station, bus station and other occasions with frequent crowd gathering and distribution;
- Oil field and coal mine remote operation occasions

# 3 Installation Instructions

## 3.1 Preparation for Installation

### 3.1.1 Basic requirements

Ensure that all electrical work must be conducted in accordance with the latest electrical regulations, fire regulations and related regulations; check whether the packaging is damaged, equipment and accessories are complete, and determine whether the application places and installation methods of PTZ product meet the requirements; please contact the dealer if necessary, please use the product according to the requirements of the working environment.

### 3.1.2 Common installation tools:

Prepare the tools actually required according to the actual situations

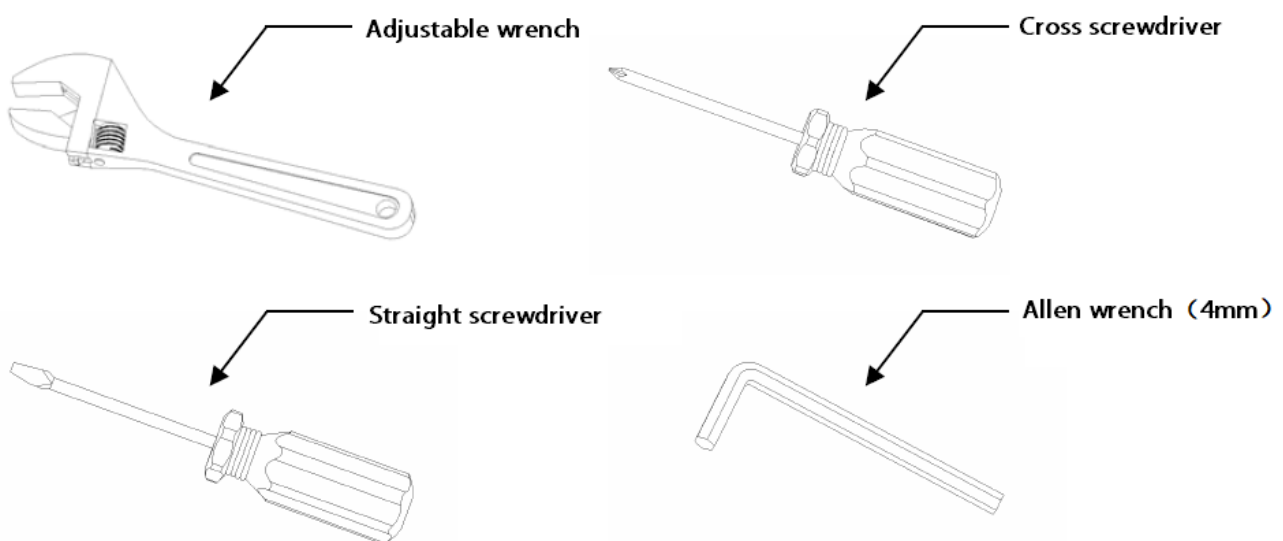

Fig.3.1 Common installation tools

### **3.1.3 Check the strength of the construction of installation space and installation site**

Confirm that there is enough space at the installation site to accommodate the product and its mounting structural part. Confirm that the carrying capacity of the ceiling, wall and bracket on which the PTZ is installed must be able to support the total weight of PTZ and its mounting structural part, with a 4 times of safety factor.

Please keep all packaging materials of network camera.

### **3.1.4 Please keep the original packaging materials of network camera properly**

After unpacking the network camera, please keep the original packaging materials of network camera properly, and pack the network camera product properly using the packaging materials of network camera and return it to the supplier for handling in case of any problem.

Note: Non-original packaging materials may cause accidental damage during transportation.

## **3.2 Installation methods of dome cameras**

This series of dome cameras support the following 4 methods of installation

1: Fig. of wall-mounted installation and dimensions

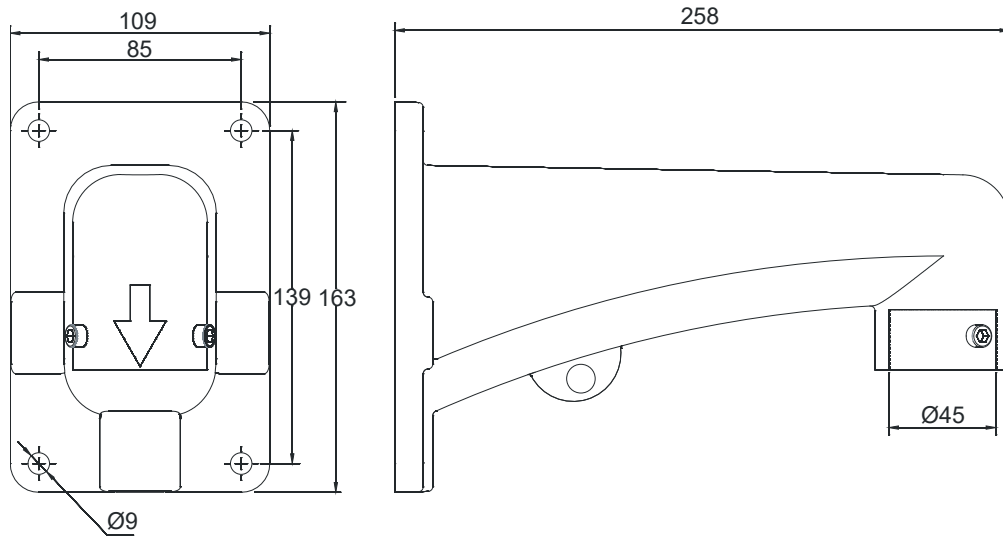

Fig.3.2.1 picture of dimensions of wall-mounted installation arm

2: Picture of ceiling-like installation and dimensions

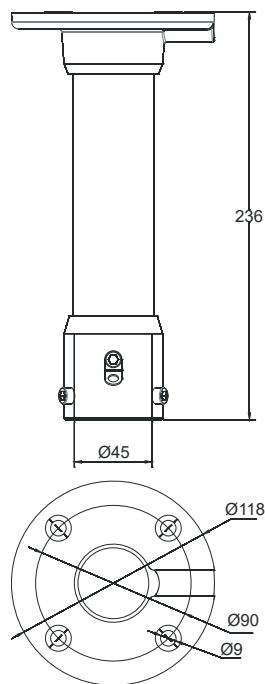

Fig.3.2.2 Picture of dimensions of ceiling installation arm

3: Picture of exterior wall angle installation and dimensions

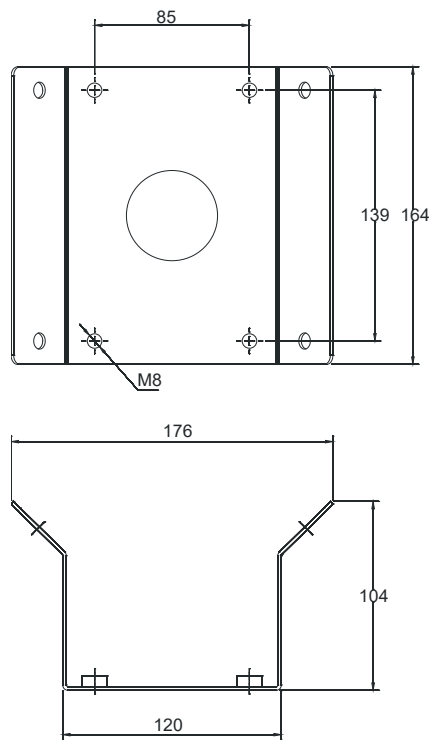

Fig.3.2.3 Picture of dimensions of external wall angle installation arm

4: Picture of column-like installation and dimensions

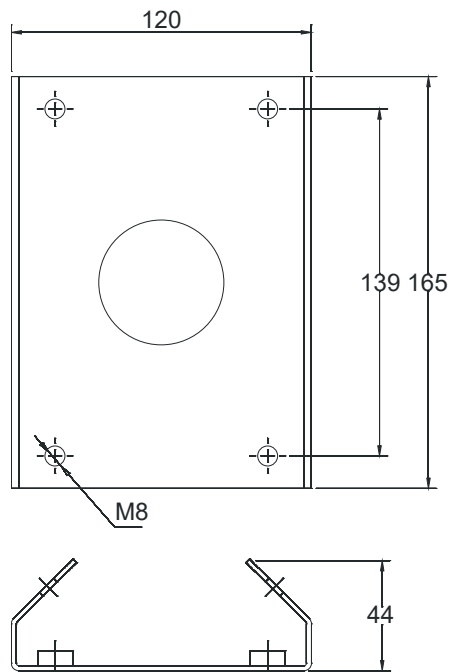

Fig.3.2.4 Picture of dimensions of column-like installation arm

### 3.3 Illustrations of dome camera and interface dimensions

This series of dome cameras adopt the split design with the joints of each part are mainly round. In order to facilitate the installation, the dimensions and specifications of this product have been listed, as shown in the figure below.

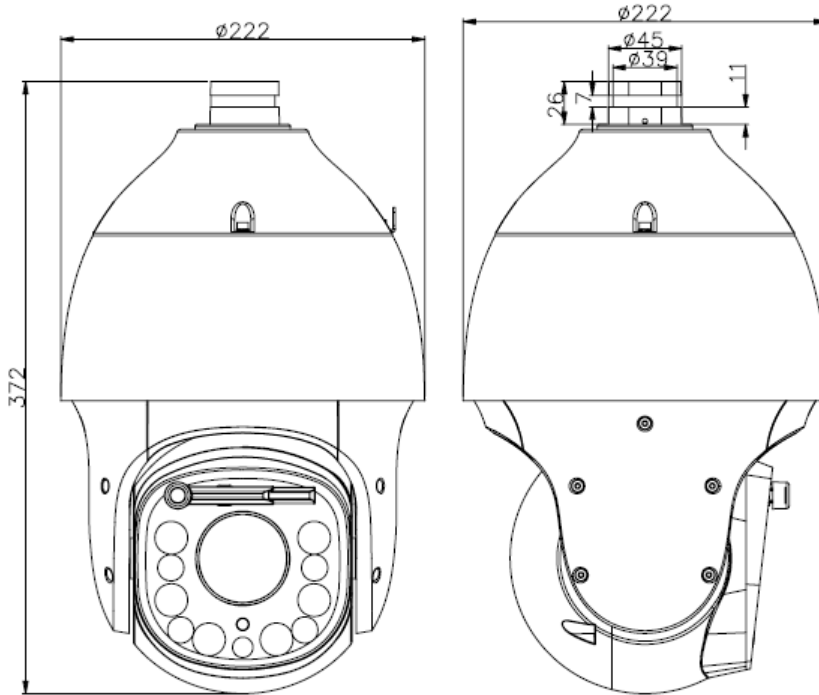

Fig.3.3.3 V3 HD infrared network high speed dome camera dimensions specification

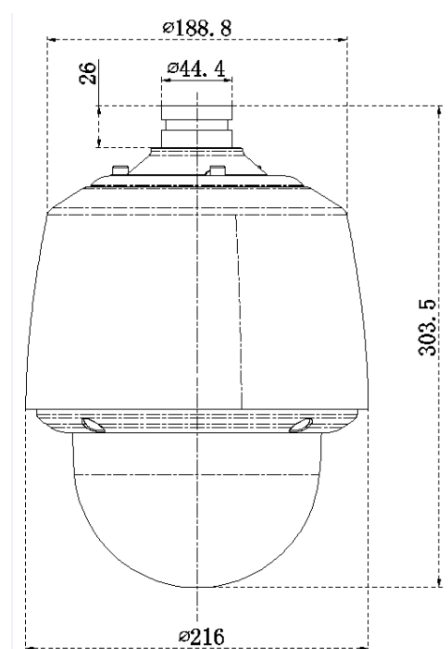

Fig.3.3.2 High-definition network high speed dome camera dimensions specification

Users can choose the bracket sold by our company, or customized bracket to install this product. The product interface dimensions are shown as follows:

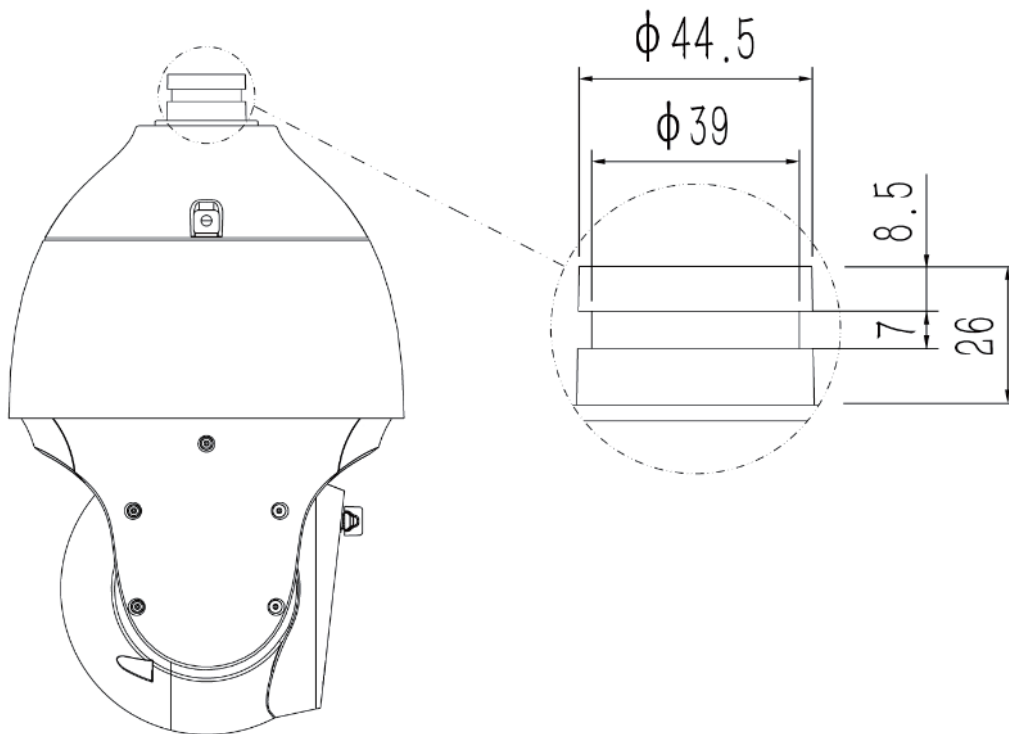
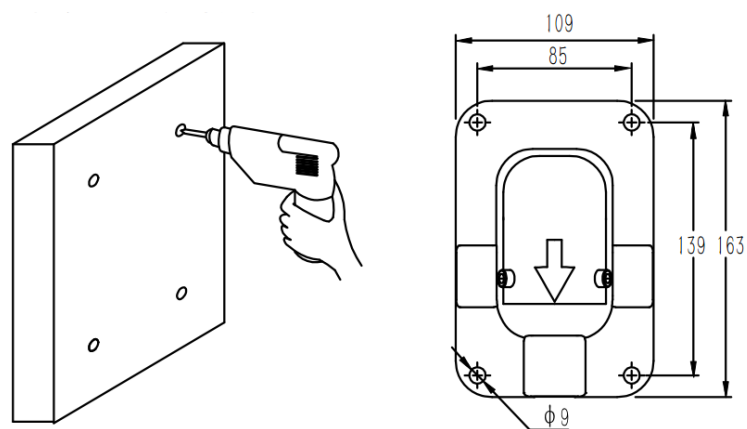

Fig.3.3.4 Picture of dome camera and interface dimensions

### 3.4 Installation steps (take wall-mounted installation as an example)

- 1、 Drill holes according to the dimensions of the bracket positioning holes.



- Hook up the body of dome camera, tighten the bracket screw, fix the dome camera and bracket and lock the spring buckle.

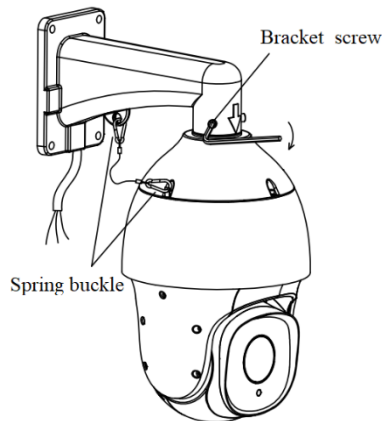

- Fasten the support arm with the expansion screw to ensure it is stable and tight to finish the installation.

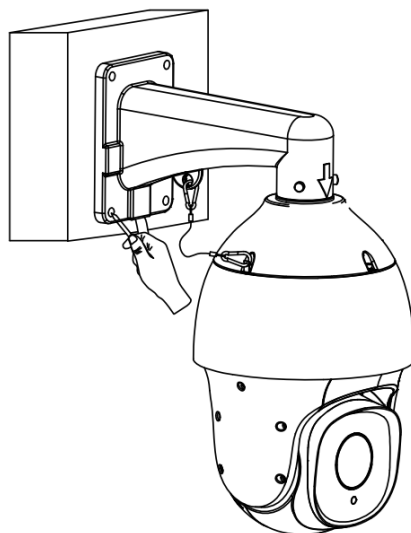

**Notes:** 1. The installation surface of the wall-mounted installation bracket must have the capacity to bear enough weight.

2. The outdoor installation shall be completely sealed and moisture-proof; the outgoing cable shall be laid close to the lower edge of the wall mounted installation bracket to avoid rain entering the interior of the dome camera along the cable.



### 3.5 Installation procedure Thermal Bi-spectrum AI PTZ Camera (take the wall mounted as an example only)

Attention: the installation height of thermal Bi-spectrum AI PTZ camera is recommended to be above 8 meters, no less than 6 meters and there should be no reflective objects within 1 meter radius of installation position.

1. The punching should in accordance with the size of brackets location hole (the same as the installation of the normal camera brackets). Fasten the bracket with expansion screw after threading out of it. The pictures of four installation ways are as below:

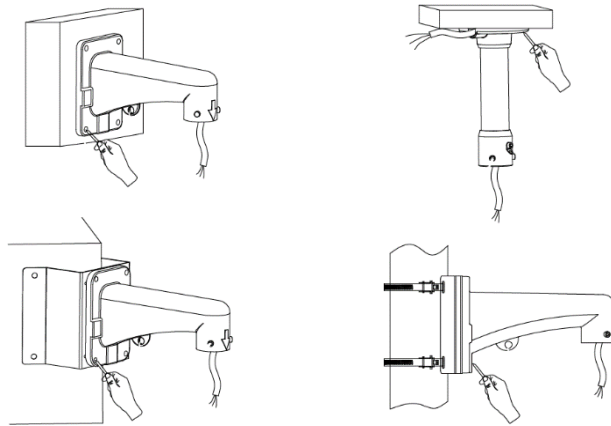

The following installation steps take wall mounted bracket as an example, which is the same as the others:

2. Thread through ball-head camera flange. The flange is then mounted upward in the bracket as illustrated, and then rotated it into the bracket in accordance with the arrow direction. The last step is locking support screws. As shown below:

Support Screw

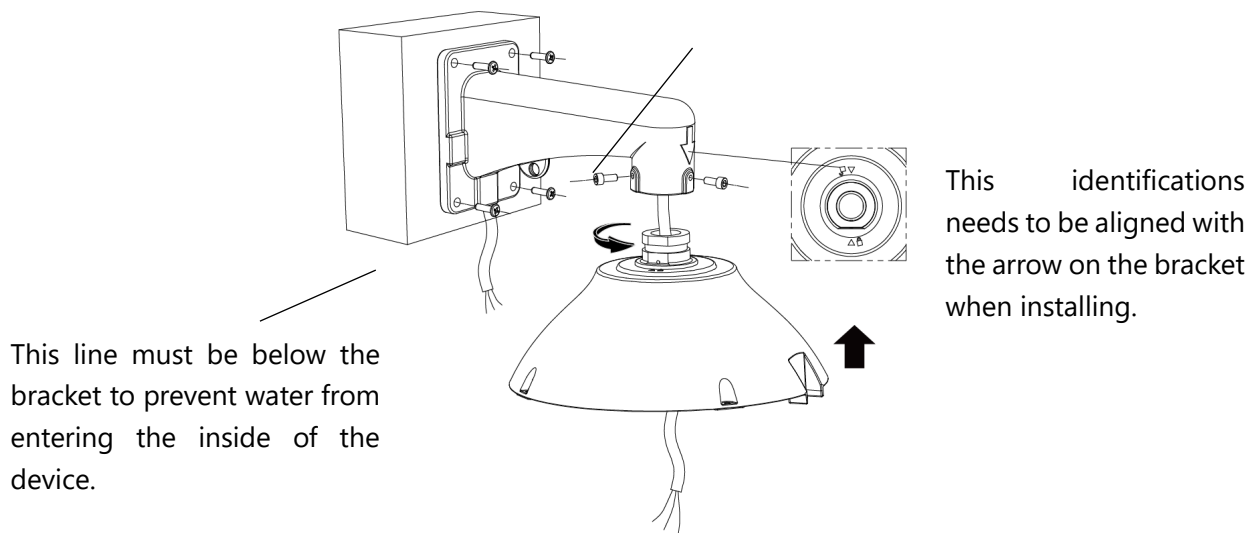

Attention: The final direction of the hook shall be parallel to the wall mounted bracket.

3. Tilting the ball-head camera then hang the hook, and hang the spring buckle, then connect the client line and the ball-head camera outgoing line in accordance with its line sign definition; there should be well insulation between different defined lines. As shown below:

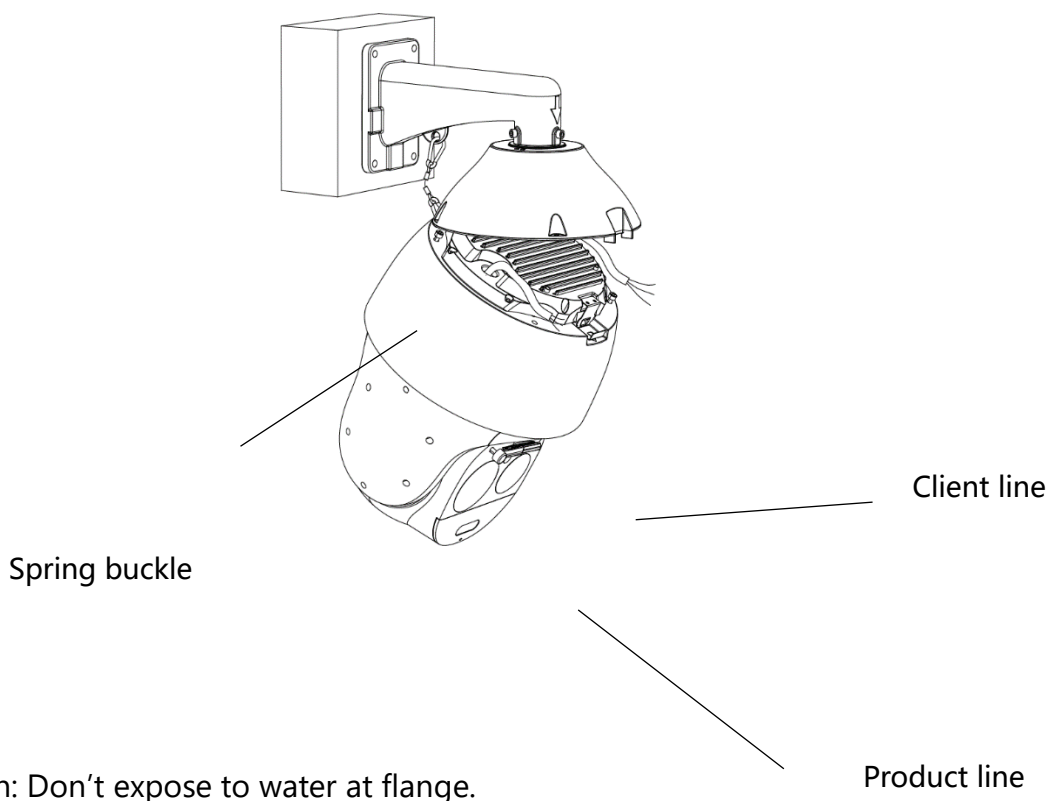

4. Lift the ball-head camera, align the gap to the locking plate, pry up to the flange and stick the lock plate, make sure 4 captive screws are fastened after locking. As shown below:

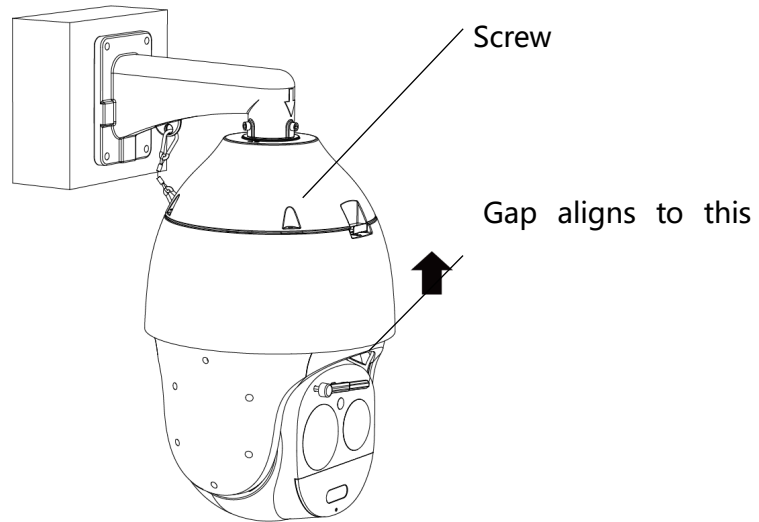

### 3.6 Illustration of external wiring

The dome camera adopts 800mm lead wire to lead out all interfaces from the inside of itself, including power wire, control wire (network wire), audio input wire, audio output wire, analog video wire, alarm input wire, alarm output wire and 485 communication wire. The connecting terminal and its color definition are shown in the figure below.

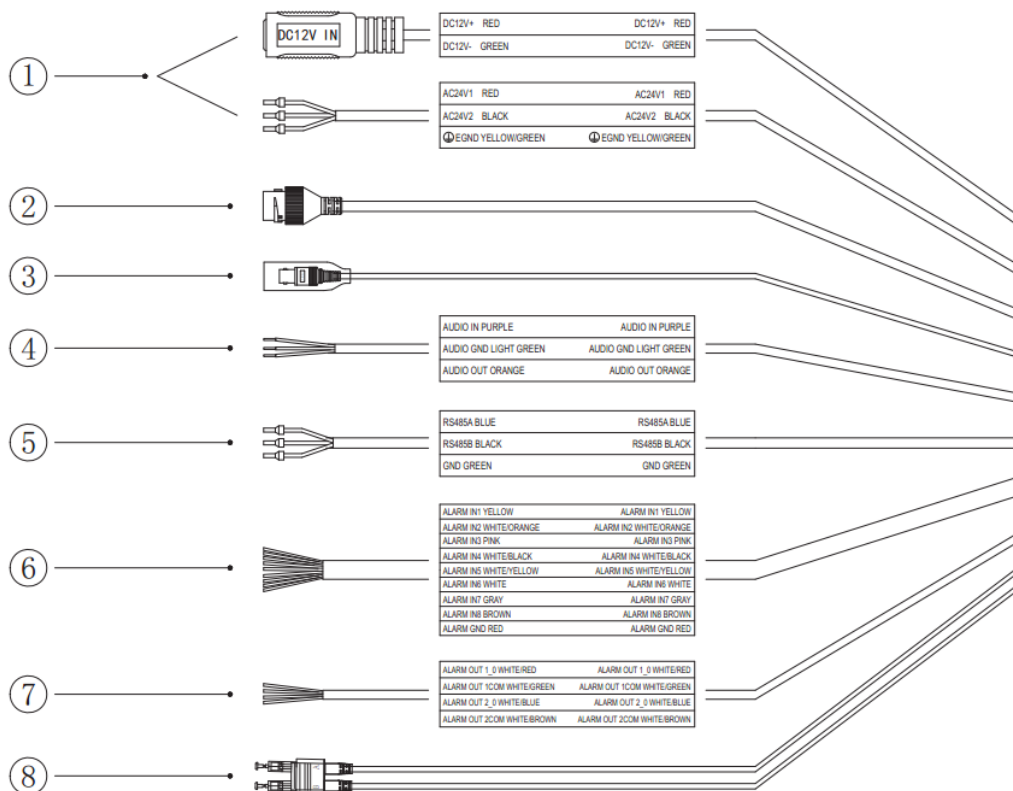

Fig.3.5.1 Lead wire of dome camera

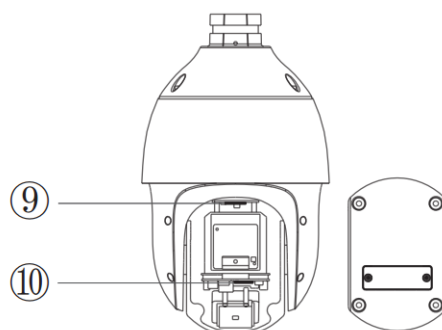

Fig.3.5.2 the description of SIM card and storage card interface

No.	Port	Description
①	Power Port	Connect AC24V or DC12V power supply based on line label or screen-printing instructions. Lighting protection ground wire: connect to the ground to avoid the damage of the equipment by lighting strike.
②	Network Port	Cable socket connects to the computer host or other network equipment.
		When connecting the network cable, it is recommended that the network cable should not be more than 100m long.
		POE power supply is supported by some models.

③	Analog video	Connect to the analog video monitor.
④	Audio port	Audio inlet connection microphone or other audio sources; audio outlet connection speaker.
⑤	RS485	The camera may be controlled by 485 port on the keyboard or other devices.
⑥	Alarm input	Connect the sensor for switch signal.
⑦	Alarm output	Connection alarm, output switch signal.
⑧	Optical fiber port	Only available for some models.
⑨	MICROSIM card interface	Only available for some models.
⑩	Memory card interface	installation of memory card specifically used for video monitoring

**Note: the specific specifications of lead lines of different dome camera models can be used according to the instructions and guides of labels on the wires.**

# 4 Descriptions of functions

## 4.1 Basic function description

This section describes the main functions of the high speed and the infrared dome cameras and the general principles of their implementation, no specific operation methods involved. The specific operation method of different system platforms varies. Generally, the operation manual of the system manufacturer shall prevail. In some cases, there will be some special requirements and operation methods. Please contact the dealer for necessary information.

- Automatic matching technology of PTZ / rotation rate

The dome camera can automatically adjust the horizontal and vertical rotation rate of the PTZ according to the multiple of variation, which makes the manual operation easier.

- Set up and call preset position
- The preset function is that the dome camera can store the horizontal angle, tilt angle, camera lens focal length and other position parameters of the PTZ in the current state into the memory. These parameters can be called quickly when necessary and the PTZ and camera can be adjusted to this position. The operator can easily and quickly set or call the preset position by controlling the keyboard or equipment.

- Automatically scanning

The operator can set the left boundary position and right boundary position in advance by controlling the keyboard or equipment conveniently and quickly to achieve the automatic reciprocating scanning of the camera between the left and right boundary at the set speed

level. This dome camera can set 8 scanning paths.

➤ Automatically cruising

The dome camera can program some preset positions into the automatically cruising queue in required order through pre-programming. The operator can easily and quickly control the keyboard or equipment to allow the dome camera automatically scan in the specified time interval according to the preset position sequence. Each cruise track can store 32 preset positions.

➤ Pattern path (pattern scanning)

The dome camera can record the running track for 180 seconds continuously. After the pattern path function is started, the dome camera can scan and monitor as the recorded running track automatically.

➤ Watch position function

The dome camera can be set to automatically perform the set standby action after reaching the standby time: preset position, cruising, scanning, pattern path. The standby time can be set.

➤ Self-recovery function after power off

The running state of the dome camera can be restored after the power is cut off and recovered to prevent the trouble of re-operating the dome camera caused by the unexpected power off effectively.

# 5 WEB client

## 5.1 Operating Environment

It is recommended to run under the operating system environment of Win7 and above. In order to better operate and use the system, and fully reflect the performance and effects, please ensure that the following items are set or installed correctly after the system is successfully installed:

- (1) The display resolution is set to 1920 × 1080 or higher, and the color is set to enhanced color (32-bit), please refer to Windows help document or online help for how to set the resolution and color of monitor.
- (2) Make sure that the font required for this system-Song font is installed in the Windows operating system. If the interface of this system is displayed abnormally, the fonts required by this system may not be installed, or the required fonts have been damaged, and fonts need to be reinstalled.

## 5.2 Instructions for embedded Web server

You need to download controls before using this series of network video products for the first time.

**Note:** Use the IE browser of Windows operating system, to ensure that the version is 8.0 or above. Except for Firefox and Google browsers, please do not use other third-party



browsers and any IE browser shell programs such as Maxthon, Window of the World. We do not guarantee that you can log in normally with such software.

## 5.3 Login Device

The default IP address of the device is: 192.168.1.2. Please set the IP address of the computer and the IP address of the device in the same network segment: for example, set the IP address of the computer to 192.168.1.3 to access the device through IE browser. Open the IE browser, input the IP address of the network video device in the address bar, and click "go" to log in to the device. If it is the first time to use, the following interface will appear.

### 5.3.1 Equipment activation

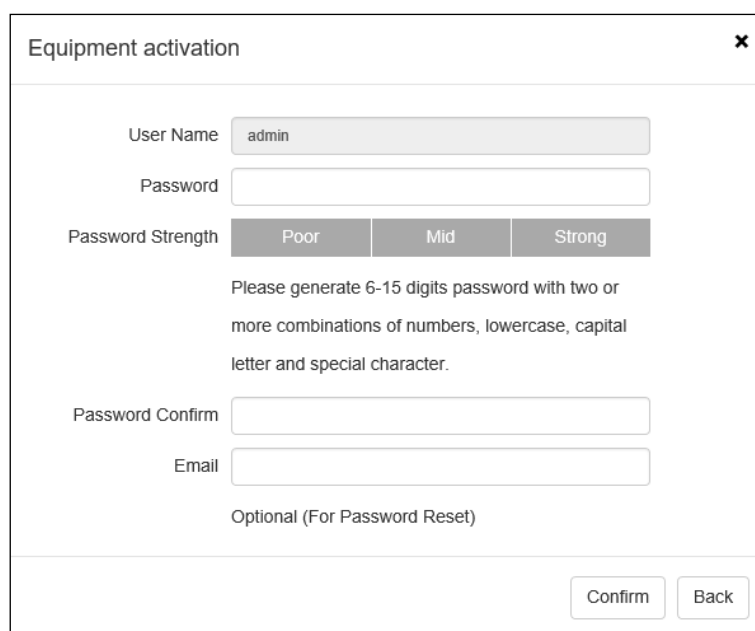

The screenshot shows a web browser window titled "Equipment activation" with a close button (X) in the top right corner. The form contains the following fields and elements:

- User Name:** A text input field containing the text "admin".
- Password:** An empty text input field.
- Password Strength:** A row of three buttons labeled "Poor", "Mid", and "Strong". The "Mid" button is currently selected.
- Instructions:** Text below the strength buttons: "Please generate 6-15 digits password with two or more combinations of numbers, lowercase, capital letter and special character."
- Password Confirm:** An empty text input field.
- Email:** An empty text input field.
- Optional (For Password Reset):** Text centered below the email field.
- Buttons:** Two buttons labeled "Confirm" and "Back" are located at the bottom right of the form.

Fig.5.3.1.1 Equipment activation interface

Some devices need to be activated before IE interface is to be used. Set the login password in the activating device window and click OK to enter the IE login interface.

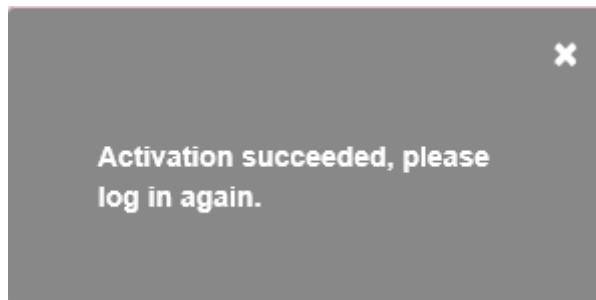

Fig.5.3.1.2 Prompt box for activating device

## 5.3.2 IE login interface

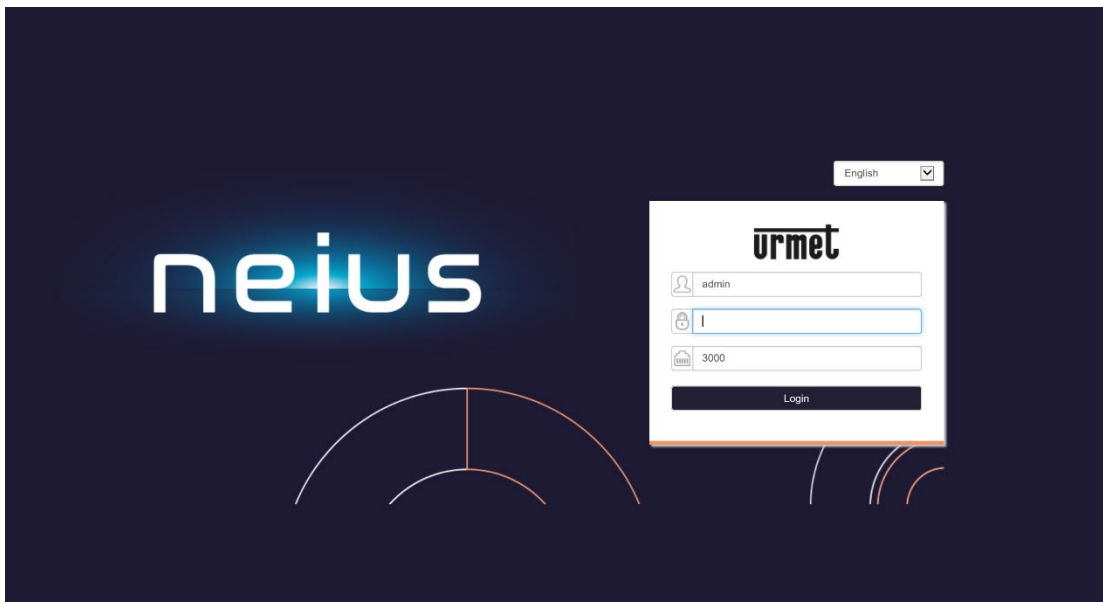

Fig.5.3.2.1 IE login interface

Enter the correct user name and password in the login window, and click “Login” to enter the preview interface later.

### **Description:**

- (1) If the equipment port number is modified, you need to enter the correct port number, and the default port number is 3000.
- (2) If the device supports activation, the password is the one set at the time of activation.
- (3) If the device does not support activation, the password is 1111.

The video preview serial interface will prompt the link to download the video plug-in as Fig.5.3.2.2. Click the link to download and install the plug-in. The IE interface needs to be closed during installation.

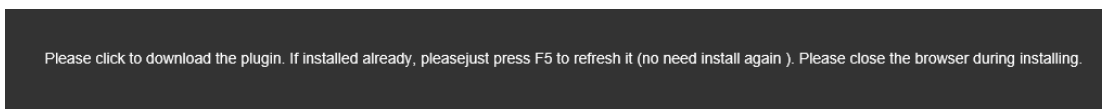

Fig.5.3.2.2 Download the video plug-in

After the video plug-in is installed successfully, enter the device IP again and log in the correct account password to enter the preview interface.

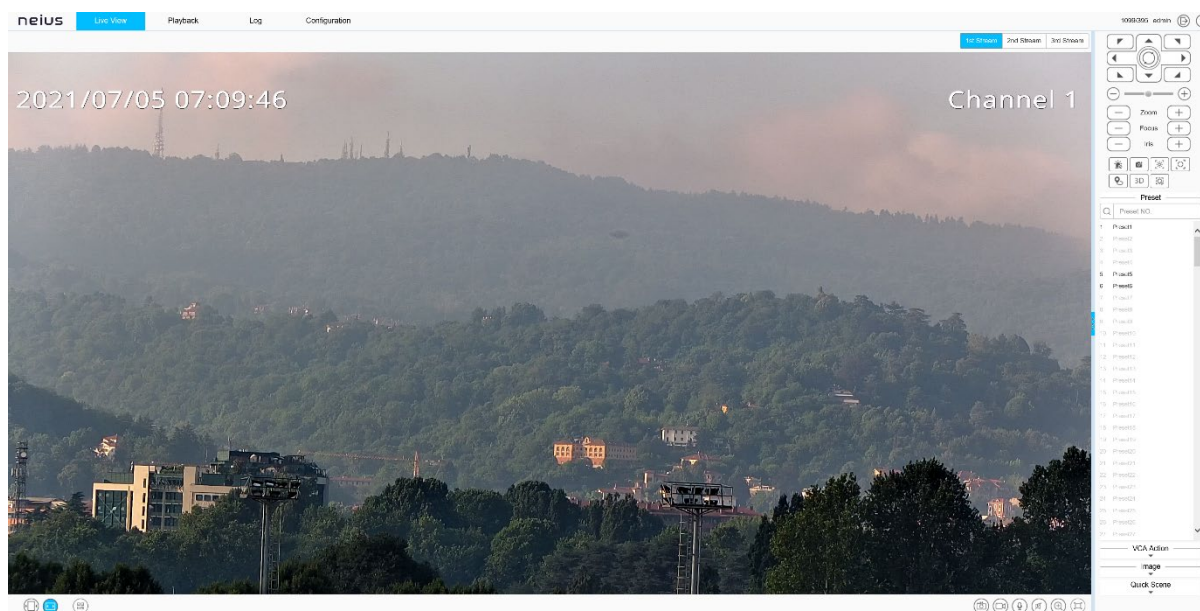

Fig.5.3.2.3 preview interface of video

After you log in to the system, the prompt box of "change password" will appear in the lower right corner of the desktop. Please click the text in the box, link to the user management interface, select the user, and click "edit", as shown in the figure below.

Note: In order to ensure the security of your information, please be sure to change the initial password!

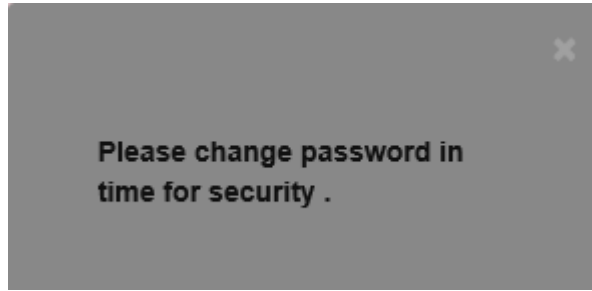

Fig. 5.3.2.4 Change password prompt box (supported by some models)

Fig. 5.3.2.5 Change the password











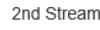
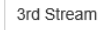



## 5.4 Audios and videos preview



After successful login, the system will display the [Live View] interface by default. In other interfaces, users can return to the video preview interface by clicking the [Live View] button at the top of the interface.

This interface mainly control basically the front-end equipment, such as the pan tilt, lens, wiper and so on.

### 5.4.1 Button of video preview interface

Icon	Description
1st Stream	Click "1st Stream"; the video window will display the primary code stream, and the primary code stream will be displayed by default.



	Click "2nd Stream"; the video window will display secondary code stream after selection.
	Click "3rd Stream"; the video window will display third code stream after selection. (supported by some models)
	1*1 split screen (supported by some models)
	1*2 split screen (supported by some models)
	2*2 split screen (supported by some models)
	PIP (picture in picture) (supported by some models)
	Click "Fixed Ratio"; the video will be displayed at a fixed scale.
	Click "Fit Window"; the video will automatically adapt to the computer resolution display.
	QR code button. QR code will appear after clicking it. Users can scan the QR code according to the type of mobile phone and download the mobile client. A third QR code will appear after the equipment is connected to the public network, and you can add the equipment by scanning on the mobile client. (Supported by some models)
	Video connection or disconnection in specified channel (supported by some models)
	Local manual snapshot control button, click enable to snapshot and save the preview picture locally, the storage path of the snapshot file can be modified by itself, the modification page: configuration system settings local settings preview snapshot save path.
	Local manual recording control button, click enable, start local recording after enabling, the storage path of recording file can be modified by itself, modification page: configuration - system settings - local settings - saving path of recording file.
	Voice intercom switch. When enabled, it can transmit local audio to the front-end equipment through the network for output.
	Audio preview volume adjustment button, the local output volume can be adjusted by adjusting the slider position.
	Electronic zoom button. After enabling this function, click the left mouse button to draw the area to be enlarged, and then you can zoom in and view the area. (Supported by some models)

	<p>Displays the frame rate button. After clicking, the preview interface displays the frame rate information of the current video. Click again to cancel the display of frame rate information. (Supported by some models)</p>
	<p>Full screen button. Realize full screen preview video, double click left mouse button or press the [Esc] key of keyboard to exit full screen preview video status</p>

### Caution

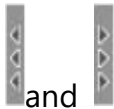
- (1) All icons are valid when pressed.
- (2) When there is no video in the interface, the audio preview is invalid.
- (3) Talk can only be conducted with one user at the same time, and it is recommended to turn off the intercom in time after completing the talk, so that others can use it.











- (4) Click  and  the arrow or on the right side of the video window to display / hide the control interface.

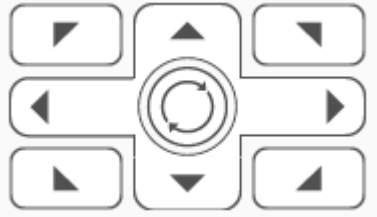

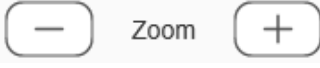
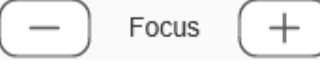
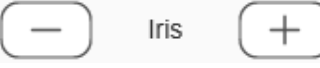





(5) Some models support "target information" to display the target and information identified by the intelligent algorithm. You can click "Zoom" / "target information" to switch the interface.

(6) Double click the left mouse button in the preview window to display the full screen. The dome camera can be controlled by keyboard: W" ↑ ", S" ↓ ", A" ← ", D" → ", I"zoom in", K"zoom out", J "focus near", L "focus far".



## 5.4.2 PTZ control

The functions supported by different models are different, please refer to the actual interface.

Icon	Description
	<p>8 direction keys, press the corresponding direction key to control the pan tilt to rotate in the corresponding direction; the center button is the scan shortcut key, press center button can invoke scan 1.</p>
	<p>The slider can adjust the rotation speed of the device. The closer the "-" end is, the slower the speed is, and the closer the "+" end is, the faster the speed is.</p>
	<p>Zoom control button, press "-" control device to perform zoom operation, the field angle becomes larger and the scenery becomes smaller; press "+" control device to perform zoom operation, the field angle becomes smaller and the scenery becomes larger. (This button can also control the electric lens for zooming)</p>
	<p>Focus control button, press "-" control device to perform focusing near operation, the near scene is clear and far away fuzzy; press "+" control device to perform focusing far operation, the far scene is clear and near fuzzy. (This button can also control the electric lens to focus)</p>
	<p>Iris control button, press "-" control device to perform aperture reduction operation, and press "+" control device to perform iris increase operation. (Supported by some models)</p>
	<p>The wiper control button supports the wiper device. Click the button and the wiper will perform an operation. In order to prolong the service life of the wiper, the wiper is equipped with low temperature protection measures, and the function of closing when the ambient temperature is lower than 0 °C.</p>
	<p>Alarm removal button. Alarm can be removed after pressing the button. (Supported by some models)</p>
	<p>Flip: control the video image to flip 180 °.</p>
	<p>Snap button: press the button to turn on the front-end interception function.</p>
	<p>Front-end intercom button. Press the button to turn on the front-end intercom function.</p>

	<p>Area exposure button: when there's a large light difference of the monitoring scene, the area to be adjusted can be selected through the area exposure function to make moderate light of the key monitoring area.</p>
	<p>Area focus button: when there's a deep and large-scale scene area of the monitoring scene, you can select the part of the scene that needs to be focused clearly through the area focus function.</p>
	<p>Click the one-key watch button to automatically set the current scene to the watch preset (default preset 1), and turn on the watch function at the same time. If you want to stop the one-key watch function, please cancel the standby action in the dome camera setting-basic setting.</p>
	<p>3D positioning button, click the mouse to control, adjust the scene to be monitored to the video center. Specific operation as follows:</p> <ol style="list-style-type: none"> <li>1、 Click the left key on the required monitoring point in the monitoring video screen, and move the corresponding point to the video center;</li> <li>2、 Press and hold the left key to the bottom right to pull down a rectangular area, then the center of the corresponding delimited area will be moved to the center of the video and zoomed in;</li> <li>3、 Press and hold the left key to the top left to pull out a rectangular area, then move the center of the corresponding delimited area to the center of the video and zoom out.</li> </ol>
	<p>Laser alarm button, click once enabling, after clicking, the laser is turned on, click again, the laser is turned off. The laser working temperature is - 15 °C - 45 °C, the longest lasting time is 300 seconds, and it will be automatically turned off if it exceeds 300 seconds.</p>
	<p>Strong light warning button, click enable, the strong light will turn on after enabling, and then click again, the strong light will turn off. (Supported by some models)</p>
	<p>Sound warning button. Click "Enable", and play the alert tone after enabling. (Supported by some models)</p>
	<p>Manual tracking button, click once enabling, and then click the target manually to track the target.</p>



	Alarm lamp warning button, click once enabling; after clicking, the lamp is turned on; clicking again, the lamp is turned off. (Supported by some models)
	Similar perspective button, click once enabling; after clicking, the visible light zooms a similar perspective as thermal imagery channel. (Supported by thermal imagery model)

### 5.4.3 Preset

After logging in the preset position number, you can select the operation of preset position, including set-up, call and delete.

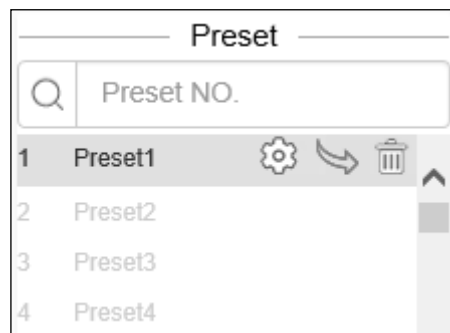

Fig. 5.4.3.1 Preset interface

The function of the presetting bit is that the camera can store the location parameters of the PTZ under the current status such as the level angle, angle of inclination and the lens focal length of the camera into the storage and the PTZ as well as the camera can be adjusted to this position through calling these parameters if necessary.

Click the button '▼' to display preset function setting interface.

Preset number can be fill in the blank and use the '🔍' button to find the target preset number to config ('⚙️') or call('↶'). Call functions are only available for existed presets.

## 5.4.4 VCA Action

Click the button ▼ Icon displays the operation interface of the intelligent action. The interface includes One-key watching, auto cruise, auto scan, pattern and intelligent scene.

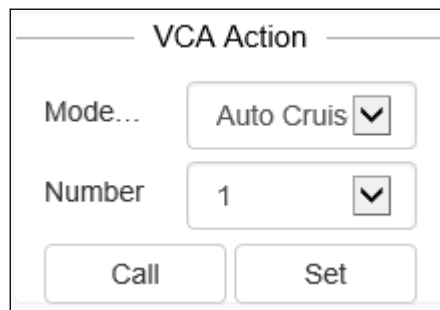

Fig.5.4.4.1 VCA Action

[Auto cruise]: Arrange some preset into the automatic cruise queue as per the requirements. Calling of this cruise can ensure the automatic cycle call of the equipment as per the set preset order as well as the stipulated interval. Each cruise trajectory can store 32 preset points.

[Auto scan]: Ensure that through set the left and right limit well in advance, the camera can scan back and forth levelly and automatically with the set speed between the left and right limit.

[Pattern]: The dome camera can continuously record the moving trajectory for 600 seconds. After the function of mode path is started, the dome camera can scan round and monitor as per the recorded moving trajectory automatically.



[Intelligent scene]: Through selecting the scene set in advance, the scene change can be realized and the function of intelligent analysis can be started quickly. If the user has set up an intelligent analysis cruise, then the cruise mode is enabled after 10 minutes.

## 5.4.5 Image

Click the button ▼ Icon display parameter adjustment interface, the interface can be adjusted by the following.



Fig.5.4.5.1 Image setting interface

Icon	Description
Day <input type="text" value="Outdoor"/> ▼	HD effect adjustment, adjust the daytime image effect. The effect is divided into:
Night <input type="text" value="Outdoor"/> ▼	HD effect adjustment, adjust night image effect. The effect is divided into: Outdoor、Indoor、WDR、Motion、Bright、Colorful、customized. etc.
	Defog function button. Click the button to turn on the defog function. (Some models support this function).
	Button for HLC function. Click the button to turn on HLC. (Some models support this function).
	Button for WDR function. Click the button to turn on WDR function. (Some models support this function).

## 5.4.6 Quick Scene

Click the button ▼ to display Scene application template interface. You can modify the parameter as follows:

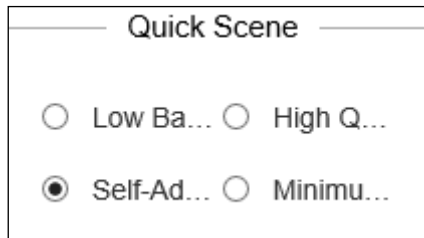

Fig.5.4.6.1 Quick Scene

Icon	Description
<input type="radio"/> Low Ba... <input checked="" type="radio"/> High Q...	According to the specific situation of network environment, choose the appropriate preview mode from [Low Bandwidth] and [High Quality].
<input checked="" type="radio"/> Self-Ad... <input type="radio"/> Minimu...	According to the network environment of equipment transmission, two transmission modes can be selected, i.e., [adaptive] and [shortest delay]. In the case of limited network bandwidth, it is suggested to choose adaptive mode to ensure smooth image; in the application environment with high video quality requirements, it is suggested to choose the shortest delay transmission mode.
<input checked="" type="radio"/> TCP <input type="radio"/> UDP <input type="radio"/> MUC	Protocol type: TCP, UDP, muc, use the specified protocol to connect video. (Supported by some models)

## 5.5 Playback

Click [playback] to enter the [playback] interface.

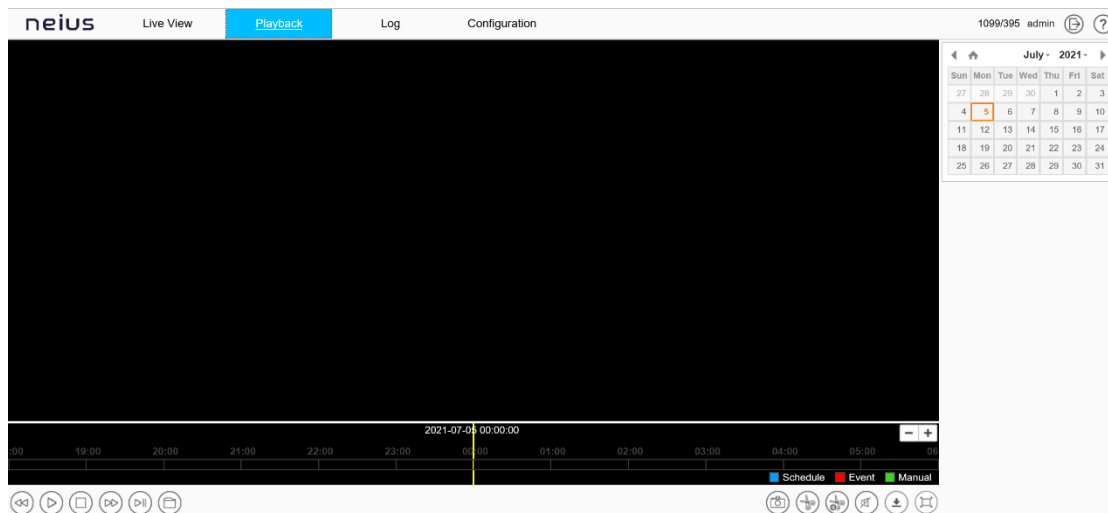











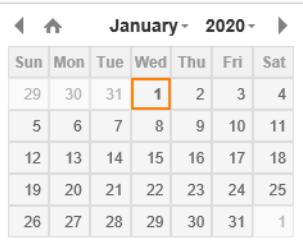



Fig.5.5 playback

## 5.5.1 Refer to the front-end video file



In the playback interface, the user can view the video files of the specified date, and can also snapshot and clip the video. See the following table for basic operation:



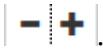

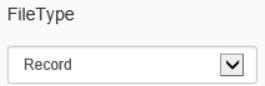
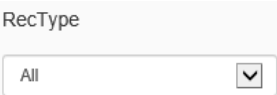
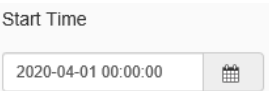
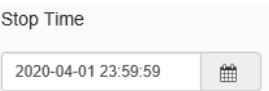

Icon	Description
	Slow forward button. The speed is 1/2 X, 1/4 X, 1/6 X and 1/8 X.
	Play / pause button. Click to start/stop playing video file. Double speed playback will be canceled if necessary.
	"Stop Playing" button. You can stop playing the current file by clicking it.
	Fast forward button. The speed is 2 X, 4 X, 6 X and 8 X.
	Stepping button can playback the video in a single frame.
	Browse button, select the video file to play.
	Playback snapshot button, saved by default in C:\Users\john\NetVideoBrowser\CapturePics\.
	Playback clip button: Click to start the clip, and click again to finish the clip. The default saving location is C: \ users \ John \ netvideobrowser \ snapshotpictures \.
	Clip Management: you can view the type of video clip, video clip progress, current status and other information.
	Volume adjustment button, the local output volume can be adjusted by adjusting the slider position.
	Download Management: query or download videos and pictures.
	Full screen play button: in full screen mode, double-click the mouse again at any position to exit from full screen mode.

	<p>Select a date in the calendar, double-click the date, and find the qualified file according to the query criteria.</p>
	<p>volume adjustment and mute</p>
<p>Stream</p> <input type="text" value="1st Stream"/>	<p>Choose the type of stream</p>

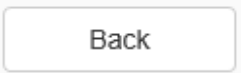
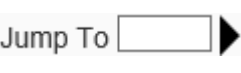
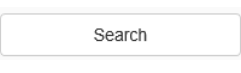
In the time axis mode, users can drag on the time axis to select and view the video files of the corresponding time. After selecting the time point, click the play button  to play. The time axis can be narrowed or enlarged by click .

In file mode, users can operate according to file type, video recording type, and whether to query remotely. The specific functions of buttons in file mode are as follows:

Icon	Description
	<p>Set the type of file to be queried, such as [Record], [Picture], etc.</p>
	<p>Select the type of video file to be queried. (Supported by some models)</p>
	<p>Select the start time of the video query</p>
	<p>Select the end of the recording query</p>
	<p>Start downloading selected video files</p>

	Stop the selected video file being downloaded.
	Return to the playback interface.
	Jump to the specified page.
	Query: Click to query the corresponding video information.
	Jump to the first page of query results.
	Go to the previous page of the current page.
	Go to the next page of the current page.
	Jump to the last page of query results.
	Lock: the file can be locked and unlocked. When the disk is full and files need to be deleted, the locked files will not be deleted.

## 5.6 Log

Click [Log] to enter the [Log] interface.

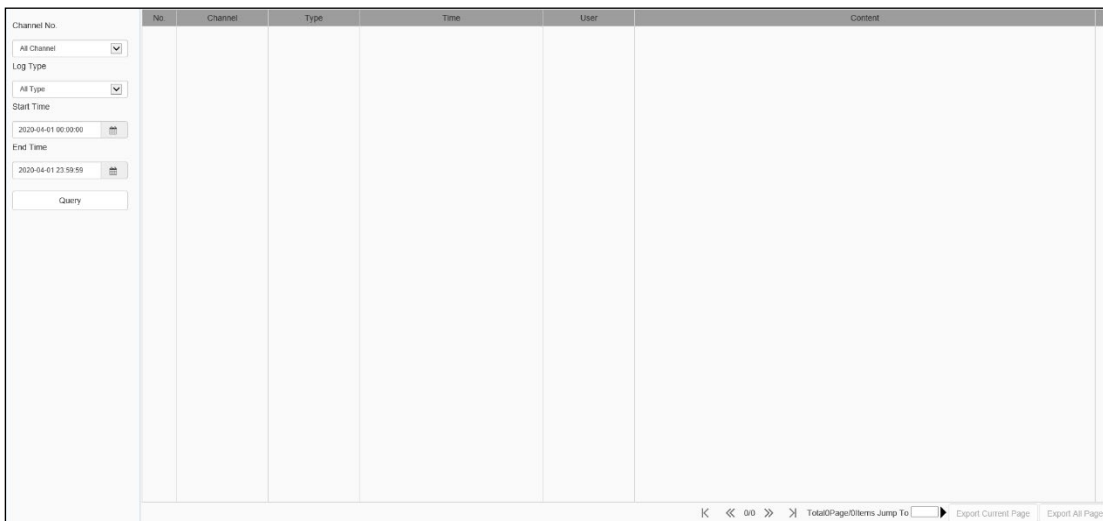

Fig.5.6 Log Interface

Log interface operation instructions

- (1) Select the channel number to query from the [Channel No.] drop-down list.
- (2) Select the type of log you want to query from the [Log Type] drop-down list.
- (3) Select the start date in the [Start Time] drop-down list, and enter the time in the edit box at the back.
- (4) Select the end date in the [End Time] drop-down list, and enter the time in the edit box next to it.
- (5) Click the [Query] button to query the logs within the specified time range.
- (6) When there are many logs, you can use [First Page], [Pre Page], [Next Page], [Last Page] in the lower right corner to turn pages to view the logs, or enter the page number to view directly in [Jump To] to jump to the specified page.
- (7) Click [Export Current Page] to export the log of current page to PC.
- (8)** Click [Export All Page] to export all the logs found to the PC.

## 5.7 Configuration

After login, [Live View] will be displayed by default. Click [Configuration] in the menu bar at the top of the page to enter the parameter configuration page, where you can set common settings, audio and video parameters, network settings, intelligent analysis, storage settings and system settings.

**Note:**

Because different models support different functions, the interfaces and menus may also be different, please refer to the actual interface



## 5.7.1 Basic Set

The screenshot displays the 'Basic Set' configuration interface, organized into several sections:

- Network:** Includes a checkbox for DHCP. Below it are input fields for IPv4 Address (192.168.15.181), IPv4 Subnet Mask (255.255.255.0), Gateway (192.168.15.1), and DNS (192.168.15.1). Further down are fields for HTTP Port (80) and RTSP Port (554).
- Video:** Features three rows of settings for different video streams. Each row includes Resolution (e.g., 5MP, 4CIF, CIF), Video Encoding (e.g., H.265, H.264H, H.264B), Encoding Mode (e.g., VBRGood, VBRNormal), Frame Rate (20), and Bit Rate (1024 or 512).
- Audio:** Shows Audio Encoding (ADPCM\_D), Audio Sample Rate (8kHz), and a Volume Value slider set to 78.
- OSD:** Contains checkboxes for Camera Title and Date, with a date dropdown menu showing 'Apr 01 2020'.
- Motion:** Includes a checkbox for 7x24 Full Area and a Sensitivity slider set to 76.
- Users:** A table listing users with columns for No., User Name, Authority, Edit, and Delete.

No.	User Name	Authority	Edit	Delete
1	Admin	Admin	Edit	

At the bottom of the interface are buttons for Save, Cancel, Import, Export, Basic Re..., and Reboot.

Fig.5.7.1.1 Basic Setting interface

### Basic Set - > Network

[DHCP]: when checked, the DHCP server will automatically assign IP to the device.

[IPv4 Address]: set the IP address of the device.

[IPv4 Subnet Mask]: set the subnet mask of the device.

[Gateway]: set the gateway of the device.

[DNS]: set the DNS server address.

[HTTP Port]: enter [HTTP port number] in the input box on the page, restart the device, and then modify the HTTP port number.

[RTSP Port]: enter [RTSP port] in the input box on the page, restart the device, and then modify the RTSP port number.

[More...]: Click  to jump to the network setting interface.

### **Basic Set - > Video**

[Resolution]: Select the necessary resolution in the pull-down list of [Resolution] and the code stream will be switched to the designated resolution.

[Video Encoding]: Select appropriate video encoding mode in pull-down list, such as [H.264], [H.265], etc.

[Encoding Mode]: It can be set as [Constant Bit Rate] or [Variable Bit Rate]. Under the mode of constant bit rate, the video data size fluctuation is small and the bandwidth is stable during network transmission. Under the mode of variable bit rate, the video data size changes with the video image complexity, and the bandwidth can be saved in single scene. Select the needed frame rate in the pull-down list; stream will switch to designated frame rate. (Frame rates supported by different N/P Mode and resolutions are slightly different, please refer to actual product)

[Bit Rate]: Select the necessary resolution in the pull-down list of [Resolution] and the code stream will be switched to the designated [Bit Rate]. (Unit: kbps)

Notes: Select the necessary resolution in the pull-down list of [Resolution] and the code stream will be switched to the designated resolution.

[More...]: Click  to jump to the network setting interface.

### **Basic Set - > Audio**

[Audio Encoding] set the audio coding mode

[Audio Sample Rate] set the audio sampling rate

[Volume value]: Can adjust the output sound, range is 100 ~ 0, The smaller the value of the device output audio signal amplitude is smaller; The greater the number of devices output audio signal amplitude is greater.

[More...]: Click  to quickly jump to audio settings

### **Basic Set - > OSD**

[Channel Title] set the character overlay name of the channel. If it is checked, it means display; if it is not checked, it means display

[Date]: Select the check box of [date and time] to overlap the date and time on the screen

**Notes:** If select the check box, the information will be overlapped on the screen.

[More...]: Click  to quickly jump to character overlay settings

### **Basic Set - > Motion**

[Sensitivity]: Set the motion alarm sensitivity.

**Notes:** Set [7x24Full Area] to enable motion alarm.

[The more]: Jump to the mobile alarm interface.

### **Basic Set - >time setting**

[Region]: The User can set the [Region] .

[Local Time]: Display the Local time.

[Set]: The User can Synchronize the system time of the device.

[NTP Server]: Setting the Server URL.

[Port]: Setting the Port Number.

[time interval]: the user can enter the interval time.

[Test]: Test and confirm the setting.

[more]: Jump to the time set interface.

## **Basic Set - > Users**

### **[New]**

To add a new user, you need to set the user name, password and permission. The user name and password can only be entered in English letters and numbers. After the above three items are filled in, click the [Save] button.

Note: only users with administrator rights can add and modify users.

### **[Edit]**

In the user list, click [Edit] to open the password modification prompt box, input the old password, new password and confirm the password, and then click Modify.

### **[Remove]**

**In the user list, click [Remove] to open the prompt box and click OK**

Basic Set - >Other buttons

Click the [Save] button to save and make it take effect.

Click [Cancel] to restore the last saved parameter.

[Import]/ [Export]: used for equipment maintenance, mainly divided into three categories:

(1) [Event Server] options include alarm time period and linkage item setting information, excluding intelligent analysis.

(2) [Smart Analytics] options include settings related to intelligent analysis, including rules,

time periods, etc.

- (3) [System Setting] options include all setting information except the above alarm and intelligent analysis, including character superposition, video recording strategy, network setting and other information.

[Basic Reset]: restore the default parameters of the device. (Key information such as IP address will not be recovered)

[Reboot]: restart the device.

## 5.8 Audio Video Set

### 5.8.1 Stream

#### Stream- > Stream

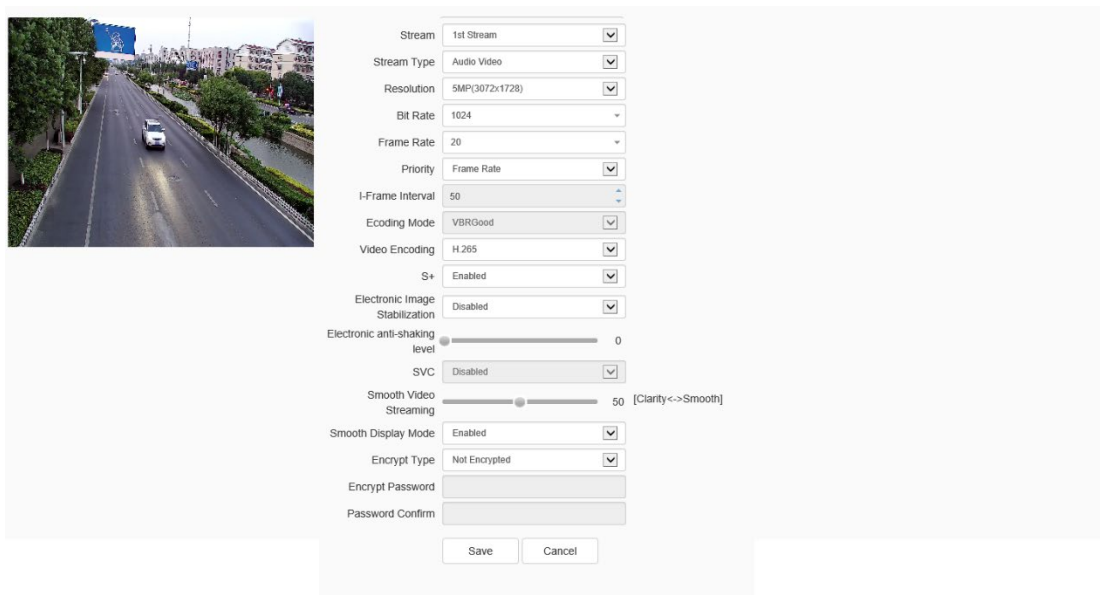

Fig.5.8.1.1 Stream - Stream interface

Related parameters of video configuration are illustrated as follows:

Parameters	Description
Stream	The video related parameters of the main stream, the sub stream and the third stream can be modified. Select the corresponding code stream of the family and modify the parameters of the corresponding code stream
Stream Type	You can choose pure video or audio video.
Resolution	Set the resolution of the video. (Different models are compatible with different maximum resolutions).
Bit Rate	Set the bit rate of the video in KB / s. Code rate range: 32 ~ 16384kb / s. Tip: select the required resolution from the [resolution] drop-down list, and the code stream can be switched to the specified [code rate]. When [compression method] is [constant rate], the [code rate] represents the actual code rate of the code stream; when [compression method] is [variable rate], the [code rate] represents the maximum allowed code rate of the code stream. (Different models support different code rates, please refer to the actual interface)
Frame Rate	Sets the frame rate of the current video. In the [PAL] system, some models support 50 frames, and the maximum support is 25 frames when the wide dynamic mode is turned on. [NTSC] under the system, some models support 60 frames, and when the wide dynamic mode is turned on, the maximum support is 30 frames.
Priority	The video set to [frame rate first] is smoother and the video set to [quality first] is clearer.
I-Frame Interval	The number of frames between every two I frames can be set, and the range can be 10-100.
Encoding Mode	Set constant rate or variable rate compression. At the fixed bit rate, the amount of video data fluctuates little, and the bandwidth occupied by the network transmission is stable; at the variable bit rate, the amount of video data changes with the complexity of the video picture, and the bandwidth is saved when the scene is single. In the case of variable bit rate, there are several levels. If the better, the higher the average bit rate is.
Corridor Mode	The screen is rotated 90 degrees to adapt to the scene where the device is installed on the wall. It is off by default.
Video Encoding	Set how video is encoded. H. 265 encoding saves bandwidth, but some browsers or playback software do not support h.265.
S+	Switch S + on and off can be selected from the drop-down list. When S + is enabled, functions such as compression mode, video quality, I-frame frame rate and key area will not be available.
Electronic Image	According to the actual situation, user can select [On] or [Off] to optimize

Stabilization	the picture quality and prevent shake. (Supported by some models)
SVC	When [SVC] is turned on, P frame can be encoded as non-reference frame, which can be used for frame extraction video recording and save storage space. The video file after frame extraction still supports normal decoding. When the [auto] mode is selected, the device will adapt to the current network environment and decide whether to send the frame to ensure that the image can be previewed normally during preview. (Supported by some models)
Smooth Video Streaming	The ratio of I frame and P frame can be set. The closer to smoothness, the better the smoothness of dynamic scene, the closer to clarity, and the better the video clarity performance of static scene.
Smooth Display Mode	Set whether to turn on unobstructed mode. (Supported by some models)
Encrypt type	According to the situation, users can encrypt video data to improve the security of network transmission. [Encrypt type] select the required encryption algorithm (currently only AES algorithm is available), [Encrypt password] set the encryption password, and [password confirmation] input the encryption password again to ensure that the password entered twice is the same. Click [Save] to take effect.

After setting, click Save to take effect. Click [reset] to restore the last saved parameter.

### Stream - > Key Region

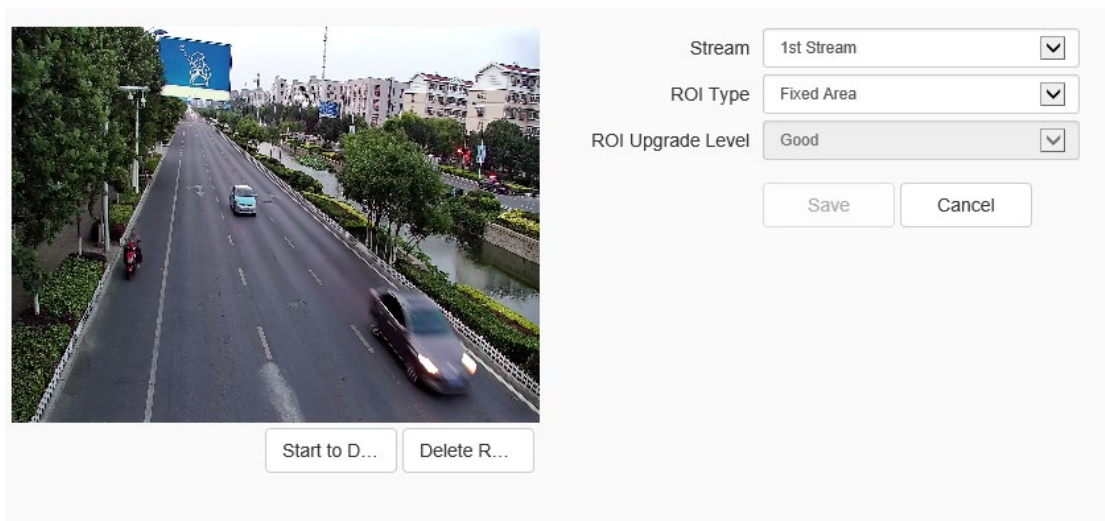

Fig.5.8.1.2 Video parameters key area interface

After the front-end connection supporting the key area setting, you can set the key area here. The image quality displayed in the focus area is higher.

- (1) Click the "Start to Drawing" button to drag the video by holding down the left mouse button, and then you can set the key area. Several key areas can be set up. Click "Delete Area" to delete all the key areas that have been set.
- (2) Click [Save] to save the corresponding parameter settings. Click [Cancel] to restore the last saved parameter
- (3) [Stream]: Select stream which needs to be set in [Stream] pull-down list.
- (4) [ROI Upgrade Level]: According to actual needs, set image quality of key region, such as [Best], [Better], [Good], [Normal] and [Poor], etc.

Select ROI Type- Status Tracking, at the same time select Initiation to track the dynamic status of key areas intelligently.

Note: after adjusting the resolution, video coding and other options, you need to adjust the code rate, compression coding and other parameters according to the actual image effect.

## 5.8.2 Audio

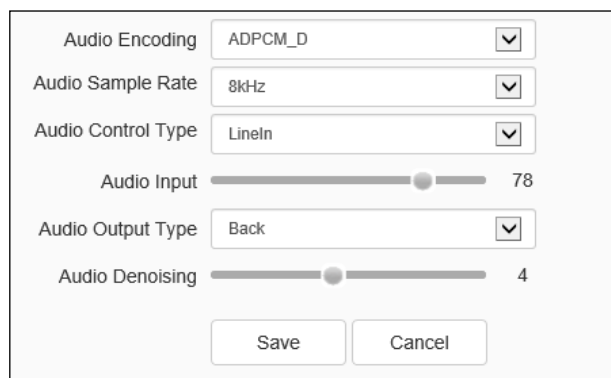

Fig. 5.8.2.1 Interface of audio parameter setting

Can modify the audio coding mode, audio sampling rate, audio control types, volume values, audio noise levels and other parameters.



Parameters	Description
Audio Encoding	Set the audio encoding mode of the bitstream.
Audio Sample Rate	Sets the audio sampling rate for the bitstream.
Audio Control Type	It supports two modes: LineIn and MicIn. The control mode needs to be selected according to the output signal amplitude of the external audio equipment. When the external mic small signal (mv level signal) is connected, please select micin; when the external equipment is the active audio equipment (V level signal), please select LineIn mode. (Supported by some models)
Volume value	The output sound size can be adjusted, and the adjustment range is 0-100. The smaller the value is, the smaller the output audio signal amplitude of the device is; the larger the value is, the larger the output audio signal amplitude of the device is.
Audio Denoising	The filter level of environmental noise can be set. The default level is 1. When the value is 0, turn off the audio noise reduction function. (Supported by some models)
Audio Output Type	The audio output type includes built-in speaker, external sound source and off. When the built-in speaker is selected, the output volume can be adjusted. (Supported by some models)
Echo Suppression	Turn on to improve the quality of audio intercom. (Supported by some models)

After setting, click Save to take effect. Click [reset] to restore the last saved parameter.

**Note:**

- (1) To modify the audio parameters, the intercom function needs to be turned off.
- (2) Modify the audio coding mode and audio sampling rate parameters.

### 5.8.3 Image Setting

## Image Setting->Image

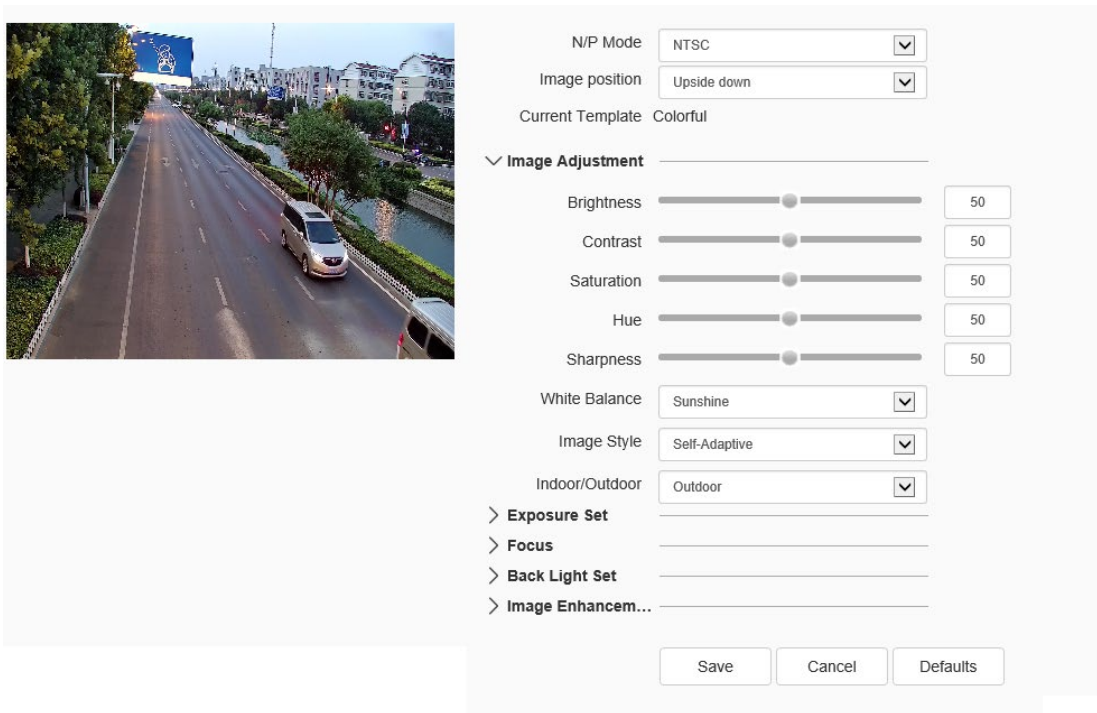

Fig.5.8.3.1 Image interface

## Image - Template Selection

In [Current Template], select the template to modify the parameter. In [ template name], you can define the template name.

Set image display effect in [[format]], PAL and NTSC can be chosen.

Select the method to display image mirror in [[Image location]]. Four methods to display image position are supported: horizontal mirror, vertical mirror, inverted flip, normal, and so on.

# Image -Image Adjustment

Click  next to [Image Adjustment] to expand the [Image Adjustment] interface. The user can set the brightness, contrast, saturation, hue, sharpness, white balance, image style and indoor/ outdoor modes of the picture through the image adjustment menu.

## Image –Exposure Set

Click the  button next to [Exposure Set] to expand the [Exposure Set] setting interface.

Parameters	Description
Shutter speed	You can set the maximum exposure time allowed to affect the brightness of the image. If the exposure time is too long, the moving image will be dragged, and if the exposure time is too short, the video picture will be darker.
SmartIR	It is mainly used for infrared night vision model. When the overexposure scene appears in the picture, the camera will automatically reduce the brightness if this function is turned on to avoid unclear objects due to overexposure.
Max Gain Set	Adjusting the maximum gain value can compensate the picture of brightness under low illumination. The larger the gain value is, the higher the brightness will be, but the greater the noise will be
Exposure Mode	There are automatic / manual / shutter priority / aperture priority. In "auto" mode, aperture, shutter and gain are adjusted automatically; in "manual" mode, shutter, aperture and gain adjustment can be set manually; in "shutter priority" mode, shutter size is adjusted manually, and other parameters are adjusted automatically; in "aperture priority" mode, aperture size is adjusted manually, and other parameters are adjusted automatically.
Brightness	Set up the desired Fig. Brightness value.
Auto Exposure Speed	Adjust the scroll bar to set up the exposure sensitivity. The larger the value is, the faster the exposure response will be when the scene changes.

## Image –Focus

Click the “ > ” button next to [Focus] to expand the [Focus] setting interface.

Parameters	Description
Focus mode	[Auto] / [Manual] / [Semi-auto] are optional. Under the [Auto] mode, focus automatically according to the monitoring scene. Under the [Manual] mode, focus clearly and manually by focusing on the preview interface. Under [Semi-auto] mode, one PTZ action triggers one focus, and there is no automatic focusing when the same scene image changes.
Min focus distance	The minimum focusing distance can be set, and it can be set as 6m for the outdoor large-scale scene and 1.5m for the indoor scene.

## Image –Back Light Set

Click the “ > ” button next to [Backlight] to expand the [Backlight] setting interface.

Parameters	Description
HLC	It is mainly used in road monitoring scenes. It can suppress the glare such as car headlights after being turned on, thus reducing the effect of glare.
Super-Wide dynamic Grade	In the drop-down list, there are [off], [ultra wide dynamic auto], [ultra wide dynamic manual] and backlight compensation options. Select [ultra wide dynamic auto] or [ultra wide dynamic manual] to display the [ultra wide dynamic] slider. Drag the slider to set the wide dynamic level that meets the requirements of the scene. The larger the value, the more obvious the effect. Select [backlight compensation] and check [set backlight compensation area] and click Save to set light compensation and improve the brightness in the setting area

## Image - Image Enhancement

Click the > button next to [Image Enhancement] to expand the [Image Enhancement] setting interface.

Parameters	Description
Defog	Select [Enabled], [Disabled] and other options according to actual needs.
Digital Noise Reduction	In the drop-down list, you can select [close], [normal mode] and [expert mode]. Select [normal mode], display the [noise reduction level] slider, drag the slider to set the noise reduction level. Select [expert mode], and the sliders of [airspace noise reduction level] and [time domain noise reduction level] will pop up respectively. Drag the two sliders to set [airspace noise reduction level] and [time domain noise reduction level] respectively.

**Note:**

After the HD parameters are set, click[Save] to save.

Click [Cancel] to restore the last saved parameter.

[Defaults]: the parameters of each template can be restored to the default settings.

**Image settings - > Schedule**

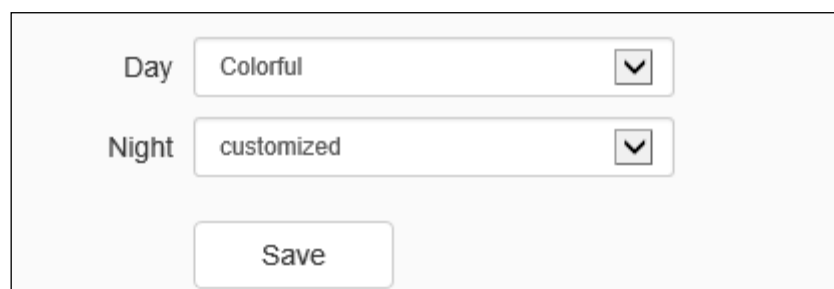

Fig.5.8.3.2 Schedule interface

Users can use different templates for equipment at different time periods by means of using HD template, to ensure that the effects of videos are the best in different time periods.

[Day]: Set the HD template during the day.

[Night]: Set the HD template at night.

Click the [Save] button to save and make it take effect.

### Image settings - > Day/Night

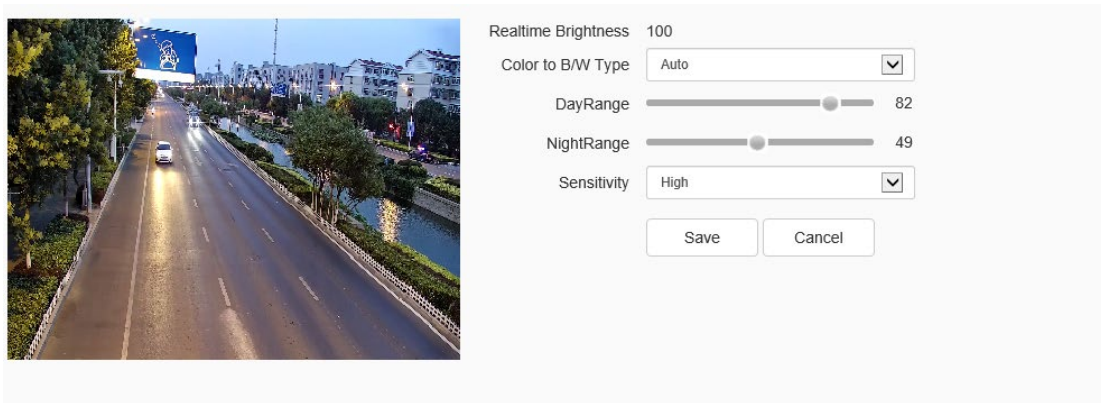

Fig.5.8.3.3 Day/Night setting interface

Parameters	Description
Color to B/W Type	It can be set as night, daytime, timing and auto. Under the auto mode, day-night image will be switched automatically.
Sensitivity	Under the auto mode, the sensitiveness of day-night switching can be set as low/medium/high, the camera will conduct day-night state switching according to the environmental illumination; the lower the sensitiveness is, the darker the day-night switching environment will be, and vice versa.
Sunrise Time	Under the timing template, the timing from black to color can be set.
Sunset Time	Under the timing template, the timing from color to black can be set.
DayRange	When it is set to automatic template, you can set up the brightness point of black to color conversion. (when it is higher than the brightness value in the daytime, it turns to the daytime mode)
NightRange	When it is set to automatic template, you can set up the brightness point of color to black conversion. (when it is lower than the brightness value in night-time, it turns to night-time mode)

## Image settings - > Fill Light Set

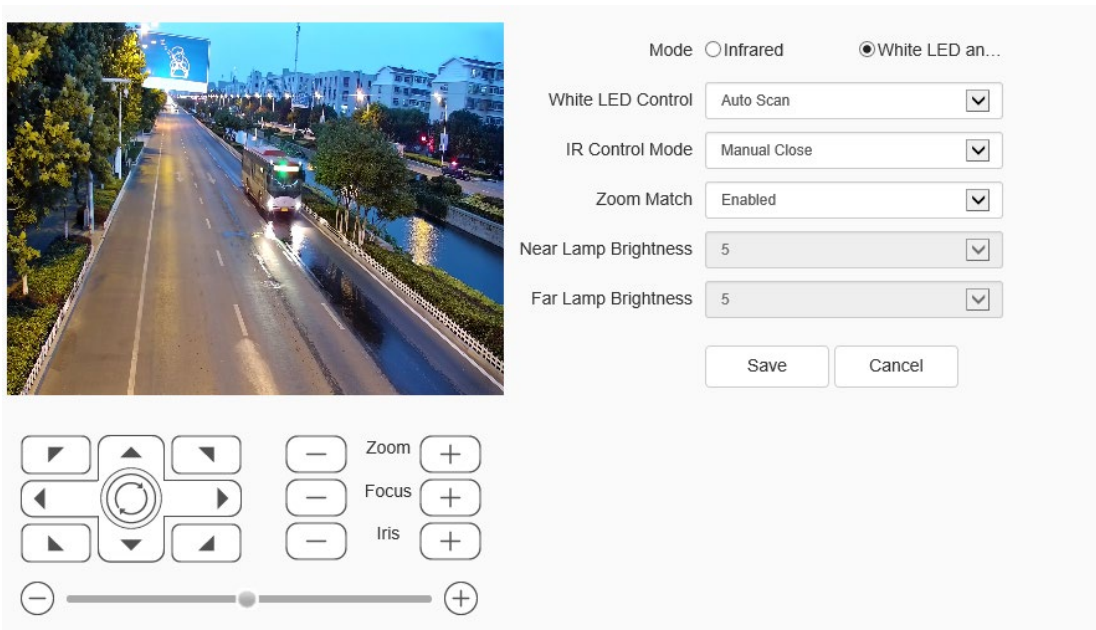

Fig.5.8.3.4 Fill Light Set Interface

For the [Mode], Select [Infrared] and [White LED and Infrared control] mode according to the actual demand:

Parameters	Description
White LED Control Mode	The white-light sources control mode includes automatic, manual starting, automatic closing and timing.
IR Control Mode	The infrared lamp control mode includes automatic, manual starting and automatic closing.
Zoom Match	When selecting the [ON] mode, the brightness and power of infrared lamp are matched with the camera irradiation distance, and the infrared lamp can realize optimal control and automatically adjust the infrared lamp bank power under different variable magnification figures. When selecting the [OFF] mode, the infrared lamp start depends on the brightness of each lamp bank set by the user, but cannot adapt to the shot variable magnification. Customers are recommended to select the variable magnification matching start function.
Near Lamp Brightness	When closing the variable magnification matching, set the low beam brightness, with the level of 0-10, and the brightness should be increased gradually.

Far Lamp Brightness	When closing the variable magnification matching, set the high beam brightness, with the level of 0-10, and the brightness should be increased gradually.
---------------------	---

[Save]: Click [Save] to save the current setting.

[Cancel]: Click [Cancel] to restore the last saved parameters.

**Note:**

(1) the light distance for white light lamp is 30 meters, when the variable magnification is over 30 meters, turn on the white light lamp manually to fill light is not recommended.

(2) For the model of the white light lamp, indoor and outdoor monitoring, if the near scene (2 to 3 meters) has a large reflective object environment, it is recommended turn off the white light lamp to avoid the repeated turn on/off of the light supplement lamp caused by the strong light reflection that will affect the image effect.

### 5.8.4 OSD

**OSD->OSD**

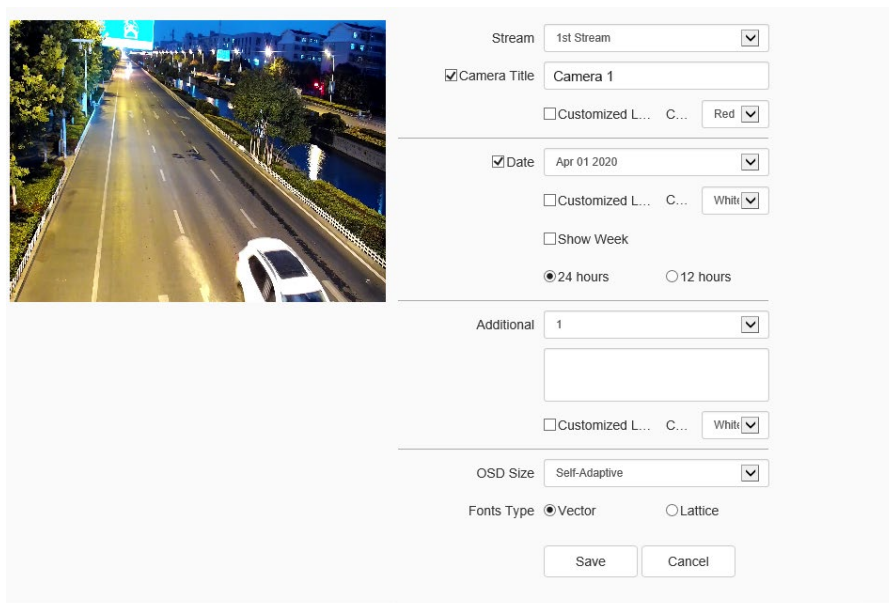

Fig.5.8.4.1 OSD Interface



[Stream]: select the code stream to stack character information.

[Channel Title]

- (1) Select the [Channel Title] check box to overlay the channel name on the screen.
- (2) Enter a name in the input box on the right to set the channel name.
- (3) From the [Color] drop-down list, select the color you like for the superimposed content.
- (4) If you need to change the position of the superimposed character, select the [user defined position] check box, and click on the small screen with the mouse to specify a new position for the superimposed character.

[Date]

- (1) Select the [Date] check box to overlay the date and time on the picture.
- (2) Select your preferred date format from the drop-down list on the right.
- (3) If you need to include the week in the displayed time and date, select the [Show Week] check box.
- (4) As required, the time can be displayed in 24-hour or 12-hour mode. Select the corresponding option from the 2 buttons below.
- (5) From the [Color] drop-down list, select the color you like for the superimposed content.
- (6) If you need to change the position of the superimposed character, select the [user defined position] check box, and click on the small screen with the mouse to specify a new position for the superimposed character.

[Additional]

- (1) [Additional] at present, there are 5 areas for stacking.
- (2) Input the text content to be superimposed from the input box below, including Chinese

characters, English and common punctuation marks. You can stack multiple lines of content in one area as needed. Some models support peripheral mode. Click [insert] to add peripheral information.

- (3) From the [color] drop-down list, select the color you like for the superimposed content.
- (4) Select the [user defined location] check box and click on the small screen with the mouse to specify a new location for the superimposed characters.

#### [OSD Size]

You can specify the size of the superimposed characters, select the preferred character size (unit: pixel) in the [OSD Size] drop-down list, or select [Self-Adaptive] to let the system automatically adjust the character size.

After all the above parameters are set, click [Save ]to save and take effect; click [Cancel]to restore the last saved parameters.

### OSD->LOGO

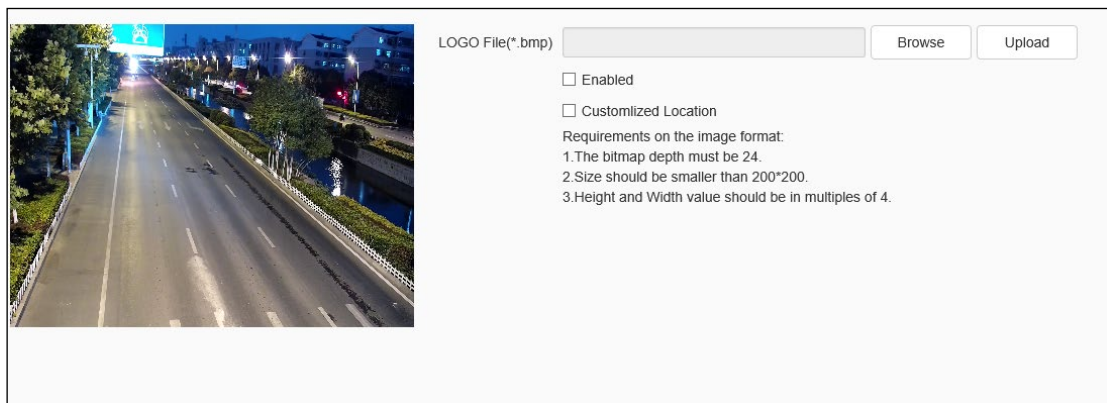

Fig.5.8.4.2 OSD-LOGO

- (1) Enter the path of the image file in the [LOGO File] input box, or click the [Browse] button to find the image file in the pop-up window.
- (2) After clicking the [Upload] button, the picture will be uploaded to the equipment, and the

equipment will restart automatically after uploading the picture.

- (3) After the equipment is restarted, select the [Enable] check box to overlay the LOGO picture on the video. If the [Enable] check box is canceled, the LOGO will not be displayed.
- (4) With [Enable]selected, select the [Customized Location] check box and click on the video screen with the mouse to specify a new display location for the LOGO.

**Note:**

- (1) The LOGO picture must be a bitmap file in bmp format. The bitmap depth is 24, the size is smaller than 200 \* 200 pixels, and the height and width are divisible by 4. Please use a picture that meets the requirements.
- (2) Overlapped LOGO will automatically remove its black and white background.

**OSD- > Privacy Mask**

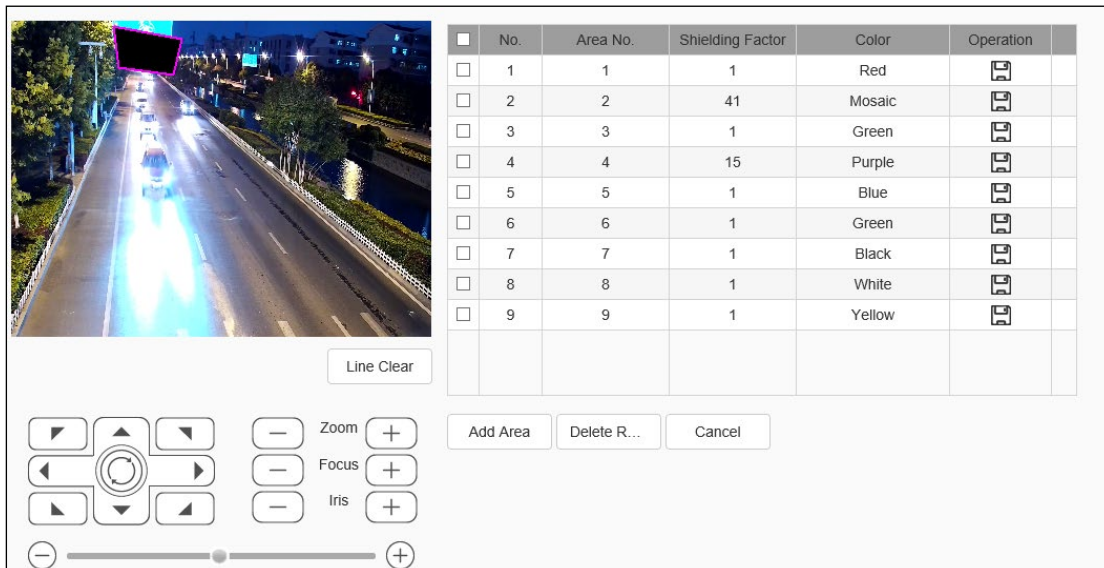

Fig.5.8.4.3 Privacy Mask setting interface

According to the user's needs, Shelter area can be set up on the picture according to the user demand to protect key information from being seen. 24 shelter areas can be set up at most for each equipment.

- (1) Draw up the area to be sheltered in the small preview window.
- (2) Click [Add area] button.
- (3) Shielding magnification: Set up the magnification value, only when the variable magnification value is greater than the shielding magnification, the private shelter area will display, or it will not display.
- (4) If the user wants to delete the shelter area, click the square frame before the serial number to select corresponding shelter area, then click [Delete area] button to delete the area.

## **5.9 Dome Set**

The specific parameters displayed depend on the specific model of the dome camera.

Please refer to the actual manual.

### **5.9.1 Basic Set**

## Basic Set -> Basic Information

Auto Flip Enable Preset Freeze... Digital Zoom Preset Snaps...

Proportion Zo... Scan Record... Mode Record... RS485 control...

Control Speed

Zoom Speed Level

Temperature Control...

Auto Stop-time(s)

Preset Speed

P/T First

Priority Delay Time(s)

Standby Action  Enabled

Standby Time

Power-lost Memory...

Fig.5.9.1.1 Basic Information

[Auto Flip Enable]: When the perpendicularity of the dome camera is 90°, the dome camera will rotate horizontally by 180° if moving along the original direction continuously.

[Preset Freeze Enable]: During the calling of preset, the image will stop at the preset all the time without showing the image during the calling and will come back when reaching the calling preset.

[Enable Digital Zoom]: After starting, when the optics variable magnification reaches to the maximum, continue to click the variable magnification to start digital variable magnification.

[Enable Preset Snapshot]: After starting, it will capture pictures during the calling preset and save them in the front-end storage medium.

[Enable Proportion Zooming]: It will adjust the operating speed automatically with the

variable magnification figure after starting; if not, all zooming speed is the same, so it is better to start.

[Enable Scan Record]: After starting, it will record during scanning, and the video files will be stored in the front-end storage medium.

[Enable Mode Record]: After starting, it will record during the mode path, and the video files will be stored in the front-end storage medium.

[Control Speed]: The control speed level includes high, medium and low levels, and the maximum speed of the PTZ can be changed by modifying this item.

[Zoom Speed Level]: The variable magnification speed level includes high, medium and low levels, and the variable magnification speed can be changed by modifying this item.

[Temperature control mode]: [Auto], [Close] and [FOG] are optional.

[Auto stop time (s)]: The auto stop time refers that the dome camera will stop the PTZ from working if it fails to receive the stop code for a long time, and it can be 5s, 15s, 30s and 60s.

[Preset speed]: The preset speed level includes high, medium and low levels, and the preset speed can be changed by modifying this item.

[P/T First]: There are two options including network and RS485. Select the PTZ priority control mode according to specific needs.

[Priority Delay Time (s)]: Delay time between two control modes. For example: The setting time is 30s; when selecting the network for the PTZ priority mode, RS485 cannot control the dome camera within 30s after the network control.

[Standby Action]: Select the [Enable] option button behind the standby action to set the standby action. The standby action includes four options such as preset 1, scanning 1, cruise 1 and mode path 1. Click the save button to save setting after modifying the standby action.

[Standby time (s)]: Select the [Start] option button behind the standby action to set the standby time. The standby time includes 30, 60, 300, 600 and 1800. Click the save button to save setting after modifying the standby action.

[Power-lost memory mode]: Save the PTZ position time automatically. After power on again, the dome camera will return to the PTZ position saved last time.

[RS485 control gimbal]: Enable the camera and 5880 / 5820 network keyboard to control the operation of the dome camera through RS485 control line.

### Basic Set -> Title

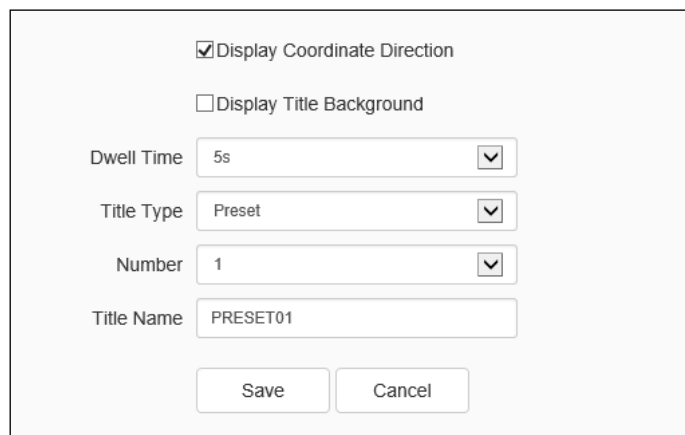

The screenshot shows a configuration window for setting a title. At the top, there are two checkboxes: 'Display Coordinate Direction' which is checked, and 'Display Title Background' which is unchecked. Below these are four input fields: 'Dwell Time' with a dropdown menu showing '5s', 'Title Type' with a dropdown menu showing 'Preset', 'Number' with a dropdown menu showing '1', and 'Title Name' with a text input field containing 'PRESET01'. At the bottom of the window are two buttons: 'Save' and 'Cancel'.

Fig.5.9.1.2 Title setting interface

[Display Coordinate Direction]: When checking the option button [Show coordinate direction], the dome camera coordinate will be shown after operation; when canceling the checking, the coordinate direction will not be shown.

[Display Title Background]: When checking [Show title background], the action title should have background color during the operation of the dome camera; when canceling the checking, the action title should not have a background color.

[Dwell Time]: Set the title standing time (such as close, continue, 2s, 5s and 10s).

[Title No.]: Select the title number, wherein the preset number range 1-32, the scanning number range 1-8, the cruise number range 1-16, the mode path number range 1-8 and the regional instruction number range 1-8.

[Title Type]: Preset, Auto Scan, Auto cruise, Mode and Zone are optional.

[Title Name]: Set the title name.

## 5.9.2 Motion Set

### Motion Set->Motion Set

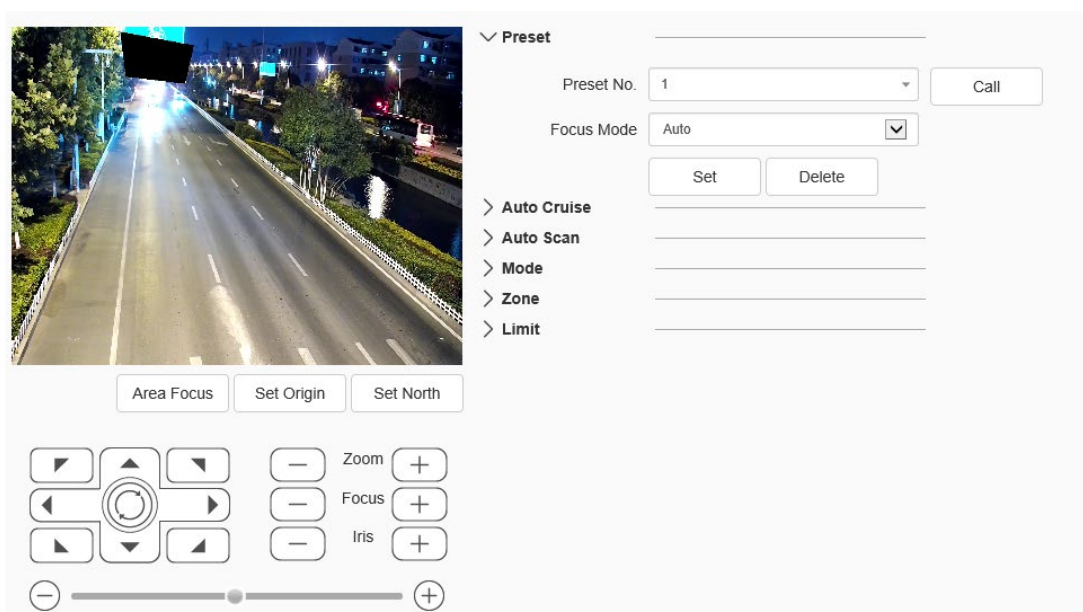

Fig.5.9.2.1 Motion Set Interface

[Area Focus]: The user can operate the dome camera by clicking Area Focus to select an area to focus when the desired position is reached.

[Set Origin]: The user can operate the dome camera, click [Set Origin] after reaching to an expected position and select an orientation zero.

[Set North]: The user can operate the dome camera, click [Set North] after reaching to an expected position and select a heading to north.



## **Motion Set - Preset set**

[Preset No.]: The dome camera can support 500 preset totally, wherein the non-special preset includes 1-64 and 100-500, and the user can set these preset.

[Focus Mode]: The focusing mode of the preset can be automatic and fixed.

[Set]: The user can operate the dome camera and click [Set] to store it at the current position when reaching to an expected position.

[Delete]: Click [Delete] to delete the preset of the corresponding number.

[Call]: Click [Call] to call the preset of the corresponding number.

## **Motion Set - Auto cruise set**

[Cruise No.]: The dome camera can support 16 automatic cruise numbers (1-16) totally.

[Cruise list]: Show the preset supported by the automatic cruise number.

[Preset]: Select 1-64 and 100-255 preset, click [Add] button and add corresponding preset to the cruise list.

[Dwell time (s)]: The standing time of corresponding preset can be set as 1-60.

[Add]: Click [Add] to add corresponding preset to the cruise list of the current automatic cruise number.

[Delete]: Click [Delete] to delete corresponding preset to the cruise list of the current automatic cruise number.

[Call]: Click [Call] to operate automatic cruise of corresponding automatic cruise number.

## **Motion Set - Auto scan set**

[Scan No.]: The dome camera can support 8 automatic scanning (1-8) totally.

DS1099-117

[Scan type]: The scanning type includes Pan Scan, Auto Scan, Frame Scan, Random Scan, Tilt Scan, Full Scan and Spiral Scan.

[Scan speed]: Change the speed of Pan Scan, Auto Scan, Tilt Scan, Full Scan and Spiral Scan by changing the scanning speed.

[Border 1]: The user can operate the dome camera and click [Border 1] to store the current position as the scanning route left boundary after reaching the expected position.

[Border 2]: The user can operate the dome camera and click [Border 2] to store the current position as the scanning route right boundary after reaching the expected position.

[Call]: Click [Call] to scan corresponding automatic scanning number.

### **Motion Set - Mode path setting**

[Mode No.]: The dome camera can support 8 mode paths (1-8) totally.

[Used(%): Show the percentage stored and used when recording the mode path.

[Left Time(s)]: Show the rest time when recording the mode path (the dome camera can support 600s record at most).

[Record]: Click [Record] to record the mode path, then the user can operate the dome camera, and the dome camera can record the user's operation.

[Delete]: Click [Delete] to delete the mode path of the corresponding mode route number.

[Call]: Click [Call] to operate the mode path of the corresponding mode route number.

### **Motion Set - Zone set**

[Zone No.]: The dome camera can support 8 regional instructions (1-8) totally.

[Left Border]: The user can operate the dome camera and click [Left Border] to store the

current position as the regional instruction left boundary after reaching the expected position.

[Right Border]: The user can operate the dome camera and click [Right Border] to store the current position as the regional instruction right boundary after reaching the expected position.

[Delete]: Click [Delete] to delete the regional instruction of corresponding regional instruction numbers.

### Motion Set - Limit set

[Enable Limit]: After checking, the movement area of the dome camera will be controlled in the limit area.

[Set]: Clicking the set button, the left preview window will show the prompt information: Set the upper/lower/left/right limit according to the prompt information; if you want to set horizontal limit rather than vertical limit, set the upper and lower limits at the same position.

[Delete]: Delete the set limit.

### Motion Set->Motion Schedule

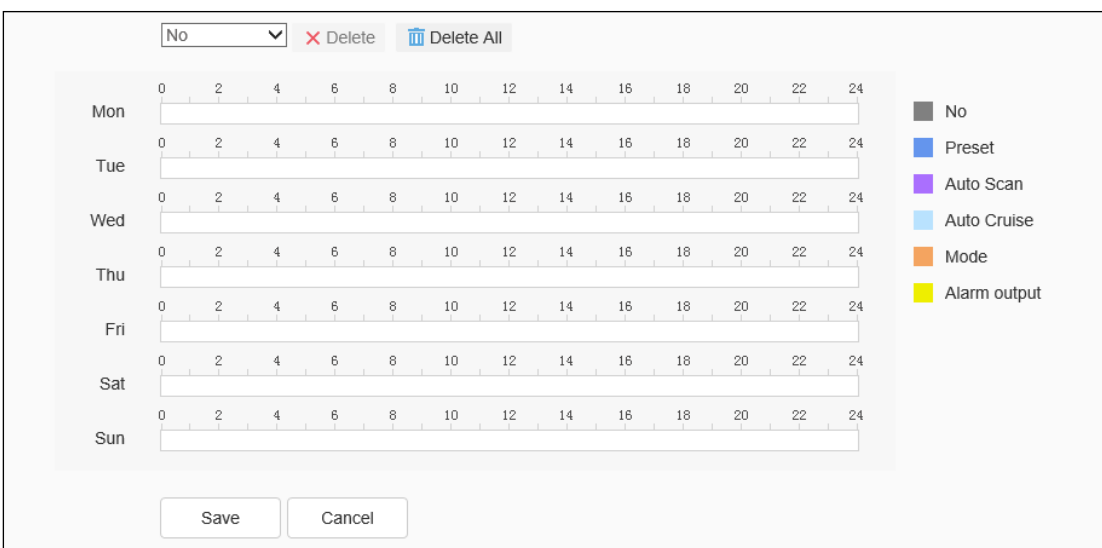

Fig.5.9.2.2 Motion Schedule Interface

Refer to complete the presetting functions in the time period specified by the user. These functions include preset, auto scan, auto cruise, mode path and alarm output.

Click the [Save] button to save the effect.

Click the [Cancel] button to restore the last saved parameter.

### 5.9.3 Remove Config

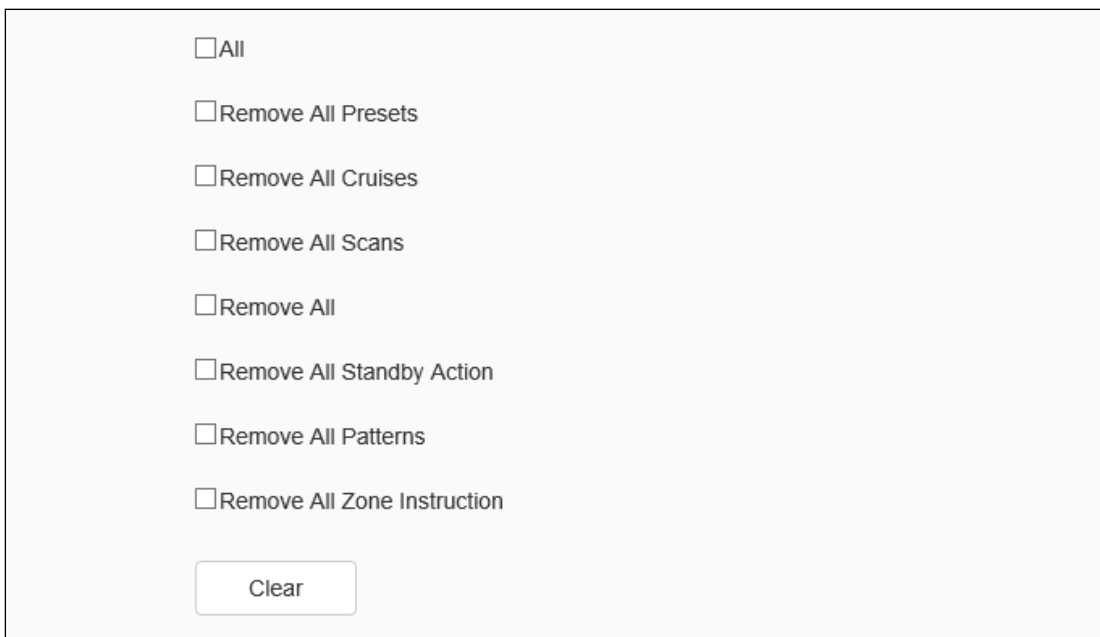

The screenshot shows a configuration window titled 'Remove Config'. It contains a list of eight items, each with an unchecked checkbox to its left:

- All
- Remove All Presets
- Remove All Cruises
- Remove All Scans
- Remove All
- Remove All Standby Action
- Remove All Patterns
- Remove All Zone Instruction

At the bottom of the list is a rectangular button labeled 'Clear'.

Fig.5.9.3.1 Remove Config

In the configuration clear interface, including select all, clear all preset, all cruise route, all scanning, all location limitation settings, standby operations, all mode path, all regional instructions, select the items to be cleared, click the clear button to clear the corresponding PTZ configuration.

## 5.10 NetWork

### 5.10.1 Basic Set

#### Basic Set->TCP/IP

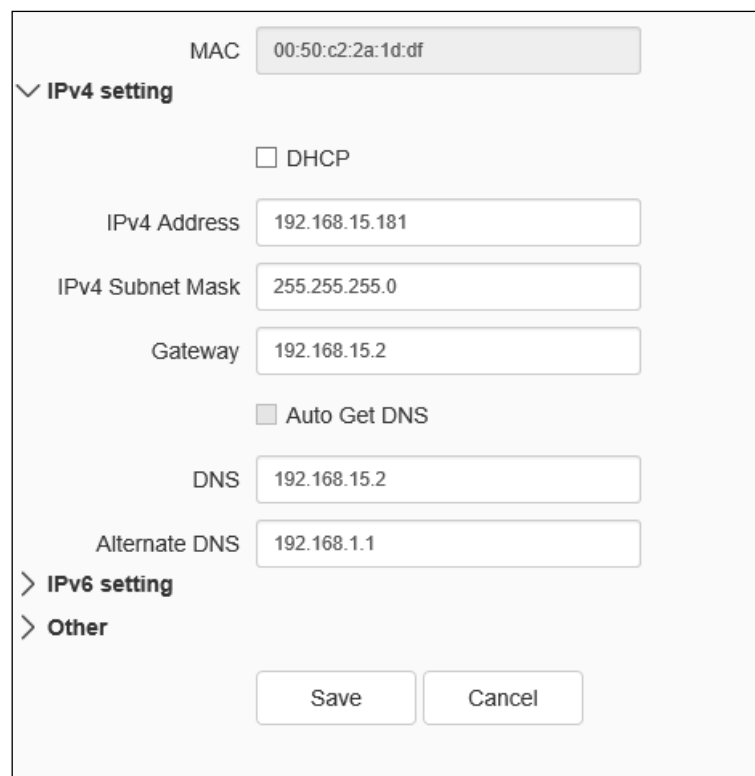

The screenshot shows a network configuration window with the following fields and options:

- MAC: 00:50:c2:2a:1d:df
- IPv4 setting (expanded):
  - DHCP
  - IPv4 Address: 192.168.15.181
  - IPv4 Subnet Mask: 255.255.255.0
  - Gateway: 192.168.15.2
  - Auto Get DNS
  - DNS: 192.168.15.2
  - Alternate DNS: 192.168.1.1
- IPv6 setting (collapsed)
- Other (collapsed)
- Buttons: Save, Cancel

Fig.5.10.1.1.1 IPv4 setting interface

MAC 00:50:c2:2a:1d:df

> IPv4 setting

∨ IPv6 setting

IPv6 mode DHCP

Link local address fe80::250:c2ff:fe2a:1ddf/64

IPv6 Address fdde:5ddd:f720::6f8 View IPv6 a...

IPv6 subnet prefix len... 64

IPv6 default gateway fe80::8eab:8eff:fed8:1409

Auto Get DNS

DNS fdde:5ddd:f720::2

Alternate DNS

> Other

Save Cancel

Fig.5.10.1.1.2 IPv6 setting interface

MAC 00:50:c2:2a:1d:df

> IPv4 setting

> IPv6 setting

∨ Other

MTU 1500

SNMP

HTTP Port 80

HTTPS Port 443

RTSP Port 554

RTSP Path rtsp://<username>:<password>@<ip>:<port>/<channel>/<stream>

channel: channel, 1 to N; stream: stream, 1st stream 1, 2nd stream 2, 3rd stream 3.

Example: rtsp://admin.admin@192.168.1.3:554/1/1

Save Cancel

Fig.5.10.1.1.3 other setting interface

[DHCP]: set whether the DHCP server automatically assigns IP to the device.

[IPv4 Address]: set the IP address, subnet mask and gateway of the device.

[IPv6 Address]: this device supports IPv6. The user can select IPv6 mode as router announcement / DHCP / Manual mode in IPv6 setting. If manual mode is selected, correct IPv6 address and IPv6 subnet prefix length (value range is 3-127) need to be entered.

[DNS]: set the DNS server address.

[MAC]: displays the physical address of the device.

[MTU]: set the size of MTU, ranging from 500 to 1500, and the default is 1500. After setting, click Save to save the setting, and it will take effect after restarting the equipment.

[HTTP Port]: enter [HTTP port number] in the input box on the page, restart the device, and then modify the HTTP port number.

[RTSP Port]: enter [RTSP port number] in the input box on the page, restart the device, and then modify the RTSP port number.

[HTTPS Port]: enter [HTTPS port number] in the input box on the page, restart the device, and then modify the HTTPS port number.

[RTSP Path]: refer to the example path in the interface. Check enable intranet search to enable this function.

[Save]: save the current settings.

[Cancel]: restores the last saved parameter.

## Basic Set - > DDNS

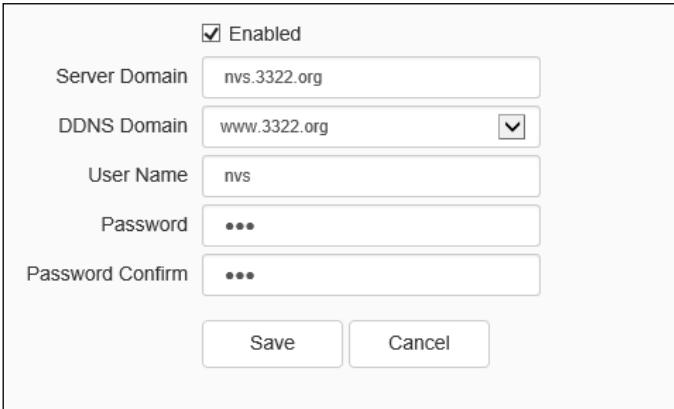

Enabled

Server Domain

DDNS Domain

User Name

Password

Password Confirm

Fig.5.10.1.2 DDNS setting interface

After checking [Enabled] DDNS, select the [server address] to be set, modify equipment [Server Domain], set [DDNS Domain], [User Name], [Password] and [Password Confirm], and then click [Save] to set DDNS network server information. Click [Cancel] to restore the last saved parameter.

## Basic Set- > UPnP

The screenshot shows the UPnP configuration interface. At the top, there is a checkbox labeled "Enabled" which is checked. Below it, the text "Mapping mode of the..." is followed by a dropdown menu currently set to "Auto".

Port Type	External Port	External IP Address	Internal Port	State
HTTP	29444	180.212.181.243	80	Activated
RTSP	43551	180.212.181.243	554	Activated
Data Port	30554	180.212.181.243	3000	Activated
HTTPS	49785	180.212.181.243	443	Activated
RTMP	31327	180.212.181.243	1935	Activated

At the bottom of the interface, there are two buttons: "Save" and "Cancel".

Fig.5.10.1.3 UPnP interface

Only when port mapping is enabled, can the ports of network devices be opened normally. Port mapping methods include automatic and manual.

- (1) When "Auto" mode is selected and UPnP is enabled, users do not need to do port mapping on the router, only need to turn on the UPnP function on the router.
- (2) Select "Manual", the user needs to manually map the port on the router. In manual mode, the user can specify the external port to be mapped under the public IP. The user does not need to modify the port of the network device itself. If the router or gateway does not support the UPnP function, the user can fill in the current mapped external port status here.
- (3) After the port mapping, the status column will show whether it is effective. At the same



time, the external port under the currently mapped public IP will be displayed in the external port. If users need to access network devices through the public network, they need to use the currently mapped external port to access.

[Save]: save the current settings.

[Cancel]: restores the last saved parameter.

## 5.10.2 Advanced Set

### Advanced Set - > IP Filter

<input type="radio"/>	No Limit	<input checked="" type="radio"/>	Whitelist	<input type="radio"/>	Blacklist
	<input type="text"/>	<input type="button" value="Add"/>	<input type="button" value="Delete"/>		
<input type="checkbox"/>	No.	IP			
<input type="checkbox"/>	1	192.168.15.189			
<input type="checkbox"/>	2	192.168.15.216			
<input type="button" value="Save"/>		<input type="button" value="Cancel"/>			

Fig.6.3.2.1 IP Filter setting interface

IP firewall, also known as black-and-white list, is provided for users to manage access rights more flexibly.

[No Limit]: select the [No Limit] button to remove the restriction of the black and white list.

All IP addresses can be accessed, not only the IP addresses in the list.

[Whitelist]: if you want to allow only a few trusted IPS to access the device, you can select DS1099-117

the [Whitelist] button, enter the trusted IP addresses one by one, click [Add] to add to the list, and then click [Save] to make the whitelist effective. At this time, only a number of IPS specified in the list can successfully log in to the device, and login requests from other IPS will be rejected, regardless of whether their user name and password are correct or not.

Users can specify up to 16 trusted IP addresses in the white list.

Note: when adding the white list, please confirm whether to add the IP address of the current user.

[Blacklist]: if you want to block some IP addresses and prohibit them from accessing the equipment, you can select the button of [blacklist], input the IP addresses you want to block one by one, click [Add] to add them to the list, and then click [Save] to make the blacklist effective. At this time, the login request from any IP in the list will be rejected, regardless of whether its user name and password are correct or not.

Note: when adding the blacklist, please confirm whether the IP address of the current user is added.

[Delete]: if you need to delete some IPS from the list, just select the check box on the left of these IPS and click [delete]. Note that all IPS cannot be deleted when deleting the white list, otherwise the device will not be able to log in successfully.

Note: IP filtering can only be judged when a user is newly logged in, and cannot filter the logged in IP. It is strongly recommended to restart the device in time after each blacklist configuration to shield the illegal IP address.

[Save]: save the current settings.

[Cancel]: restores the last saved parameter.

## Advanced Set - > Email

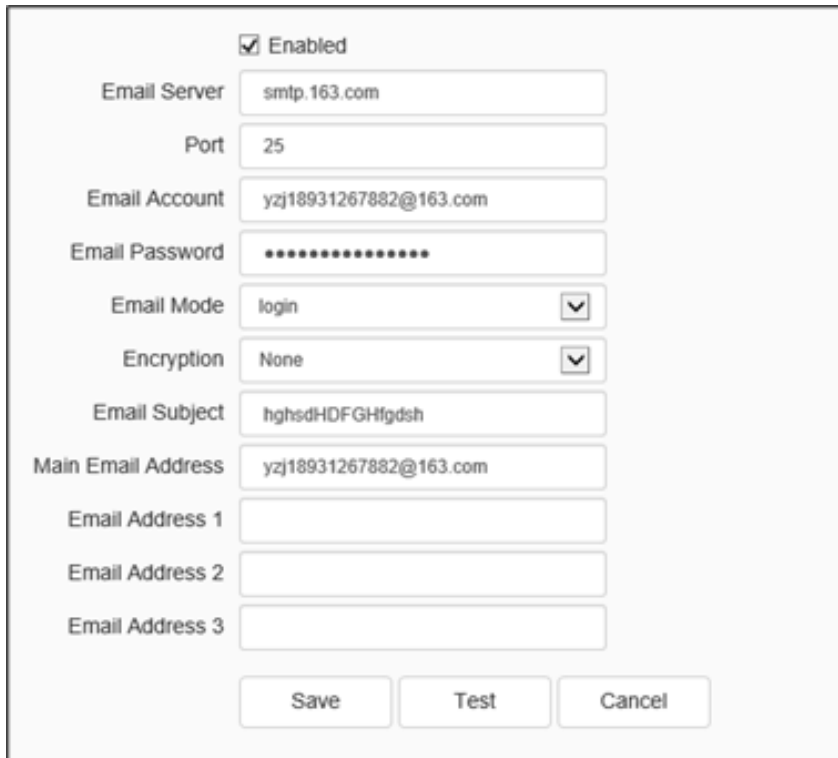

The screenshot shows a configuration window for email settings. At the top, there is a checkbox labeled 'Enabled' which is checked. Below this are several input fields and dropdown menus:

- Email Server:** smtp.163.com
- Port:** 25
- Email Account:** yzj18931267882@163.com
- Email Password:** A field filled with 12 dots for masking.
- Email Mode:** A dropdown menu with 'login' selected.
- Encryption:** A dropdown menu with 'None' selected.
- Email Subject:** hgbsdHDFGHfgdsh
- Main Email Address:** yzj18931267882@163.com
- Email Address 1:** An empty text field.
- Email Address 2:** An empty text field.
- Email Address 3:** An empty text field.

At the bottom of the window, there are three buttons: 'Save', 'Test', and 'Cancel'.

Fig.5.10.2.2 Mail setting interface

After the user enables mail, the alarm server will automatically send alarm mail to the mailbox address set by the user when an alarm occurs.

- (1) The email server address input format is smtp.xx.com, where XX represents the email server and is the login email of the account, for example, smtp.163.com.
- (2) The account and password are the user name and password of the login SMTP server mailbox.
- (3) The encryption mode can be none, SSL or TLS.

After setting the subject and CC email address, click [test ]to test whether the mail server function is normal. Click [save] to save the current settings. Click [reset] to restore the last saved parameter.

## Advanced Set - > PPPoE



Enabled

User Name

Password

Password Confirm

Fig.5.10.2.3 PPPoE setting interface

After enabling the [PPPoE] function, change the [User Name],[ Password ]and [Password Confirm], and [Save] to set the PPPoE network server information, which will take effect after restart;[Cancel]to restore the last saved parameters. (supported by some models)

## Advanced Set - > SIP

Server IP	<input type="text"/>
Server Port	<input type="text" value="0"/>
Server ID	<input type="text"/>
Device ID	<input type="text"/>
User Name	<input type="text"/>
Password	<input type="text"/>
RegValidity	<input type="text" value="0"/>
Keep-Alive	<input type="text" value="0"/>
Heartbeat Interval	<input type="text" value="0"/>
Heart Rate	<input type="text" value="0"/>
<input type="checkbox"/> Need to Register	
Channel No.	<input type="text" value="Channel1"/>
Channel ID	<input type="text" value="0"/>
Channel Level	<input type="text" value="0"/>
PTZ Time	<input type="text" value="0"/>
Event Input	<input type="text" value="1"/>
Event Input No.	<input type="text" value="987654321021111112"/>
Event Level	<input type="text" value="1"/>
<input type="button" value="Auto Filling Set"/>	
<input type="button" value="Save"/> <input type="button" value="Cancel"/>	

Fig.5.10.2.4 SIP setting interface

The SIP protocol can be accessed to other platforms by setting corresponding parameters.

[Auto Filling Set]: click this button, the channel number and alarm input number will be increased and set from the current channel number.

[Save]: save the current settings.

[Cancel]: restores the last saved parameter.

### Advanced Set - > Multicast

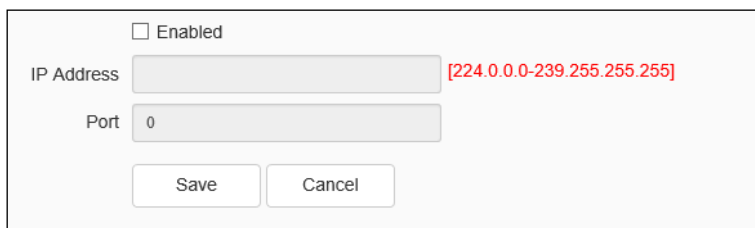

Fig.5.10.2.5 Multicast setting interface

Input the multicast [IP Address] (range: 224.0.0.0-239.255.255.255), input the port number (range: 1-65535), and click Save to restart the device. (supported by some models)

### Advanced Set - > QoS settings

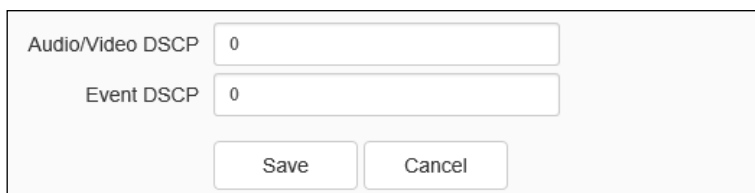

Fig.5.10.2.6 QoS setting interface

[Audio/Video DSCP] input the DSCP parameters in the input box, disconnect and reconnect the video stream parameters to take effect, and [Event DSCP] input the DSCP parameters in the input box, and click [Save] to save the parameters. (supported by some models)

### Advanced Set - > Access Platform



Fig.5.10.2.7 Platform access setting interface

[Platform Enabled]

Support the enabling and shutting down of onvif, RTSP, P2P and CGI. After setting, some devices will restart automatically and take effect.

Note: to replace the access platform, you need to first disable the enabled platform, and then select a new platform and enable it.

[Auto Filling Set]: click this button, the channel number and alarm input number will be increased and set from the current channel number.

[Save]: save the current settings.

[Cancel]: restores the last saved parameter.

### **Advanced Set - > authentication type**

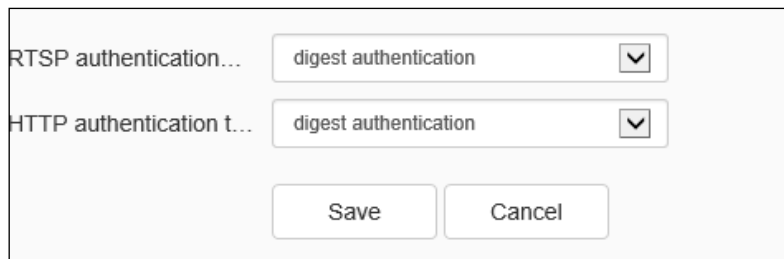

The screenshot shows a configuration window with two rows of settings. The first row is labeled 'RTSP authentication...' and has a dropdown menu set to 'digest authentication'. The second row is labeled 'HTTP authentication t...' and also has a dropdown menu set to 'digest authentication'. Below these rows are two buttons: 'Save' and 'Cancel'.

Fig.5.10.2.8 authentication type interface

Set authentication type on RTSP and HTTP as needed.

[RTSP authentication type]: Digest and digest&basic authentication types are supported.

[HTTP authentication type]: Digest and digest&basic authentication types are supported.

[Save]: save the current settings.

[Cancel]: restores the last saved parameter.

### **Advanced Set - > HTTPS**

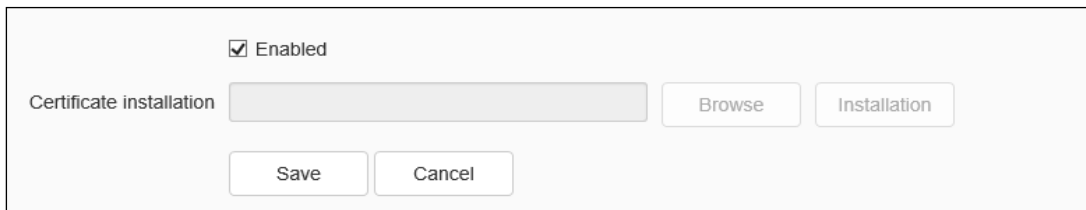

Fig.5.10.2.10 HTTPS Interface

Import and install HTTPS certificates as needed.

[Browse]: Browse the file directory and import the HTTPS certificate.

[Installation] Install the HTTPS certificate.

[Save]: save the current settings.

[Cancel]: restores the last saved parameter.

## 5.11 Event Schedule

### 5.11.1 Event Management



## Event management - > Event Input

The screenshot shows the 'Event Input' configuration page. At the top, there are tabs for 'Event Input', 'Event Output', 'Motion', 'Mask', and 'Other Alarms'. The 'Event Input' tab is active. Below the tabs, there are two dropdown menus: 'Input Port' (set to 1) and 'Mode Set' (set to NO). To the right of the 'Input Port' dropdown is an 'Enabled' checkbox. Below these are two buttons: 'Schedule' and 'Linkage...'. Underneath, there are two buttons: 'Delete' (with a red X icon) and 'Delete All' (with a trash can icon). The main area contains a 7x24 grid representing the schedule for each day of the week (Mon-Sun). Each row represents a day, and each column represents a time slot from 0 to 24 in increments of 2. All cells in the grid are filled with a solid blue bar, indicating that the event is scheduled for the entire 24-hour period of every day. At the bottom of the interface, there are three buttons: 'Copy to...', 'Save', and 'Cancel'.

Fig.5.11.1.1.1 Event input setting interface

Set port event detection related parameters.

- (1) Select the input port, check the [Enable] check box to enable the port alarm detection function, and uncheck to turn off the port alarm detection function.
- (2) [Mode Set] set normally open and normally closed, where [NO] refers to the alarm when the disconnected line is short circuited, and [NC] refers to the alarm when the connected line is disconnected.
- (3) The user can set the [Schedule] as required, and only detect the alarm within the set date and time period.
- (4) Set [Linkage Mode] to realize the alarm linkage after triggering the alarm, such as [Common link], [Alarm Output], [Link Snap], [PTZ linkage channel], etc. As shown in the

figure below

Input Port	1	<input type="checkbox"/> Enabled		
Mode Set	NO			
Schedule <a href="#">Linkage...</a>				
Common Link	Alarm Output	Link Rec	Link Snap	PTZ Linkage...
<input type="checkbox"/> Laser	<input type="checkbox"/> 1	<input type="checkbox"/> [1] Channel 1	<input checked="" type="checkbox"/> [1] Channel 1	<input type="checkbox"/> Preset
<input type="checkbox"/> White Light	<input type="checkbox"/> 2		<input type="checkbox"/> FTP	1
Flashing			<input type="checkbox"/> Email	<input type="checkbox"/> Mode
<input type="checkbox"/> Sound				1
Warning V				<input type="checkbox"/> Cruise Path
				1
Copy to... Save Cancel				

Fig.5.11.1.1.2 Linkage Mode Setting Interface

(5) Click [Save] to save the corresponding parameter settings, and click [Copy to...] copy the parameters of the current port number to other port numbers. Click [Cancel] to restore the last saved parameter.

**Note:** alarm input and alarm linkage output are limited to products that support alarm input and alarm output functions.

### Event Management - > Event Output

Output Port	1
Mode Set	NC
Delay Time(s)	10
Save Cancel	

Fig.5.11.1.2 Event output setting interface

The user can select two modes to set: [NO] and [NC]. Select the output port, set the port alias, select the mode setting, and select the alarm elimination mode. You can set the delay time of the alarm state through [Delay Time(s)].

Click [Save] to save the corresponding parameter settings, and click [Copy To...] copy the parameters of the current port number to other port numbers. Click [Cancel] to restore the last saved parameter.

## Event Management - > Motion

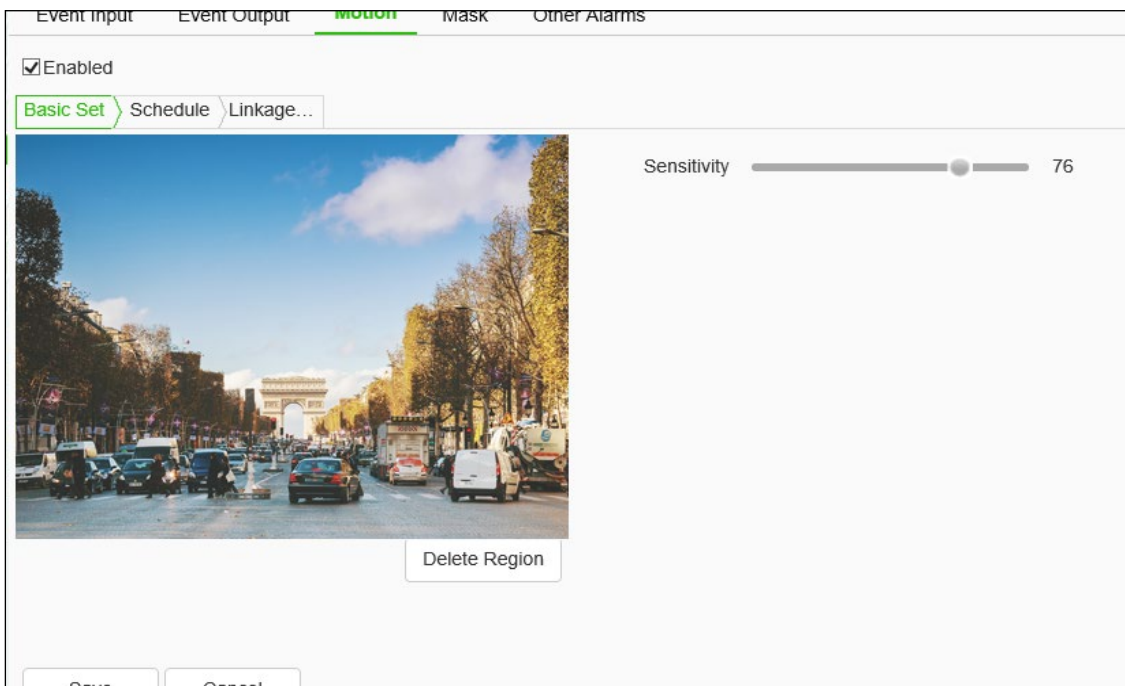

Fig.5.11.1.3 Motion setting interface

The user sets the mobile alarm area. When there is an object moving in the setting area, the video preview interface will prompt the video mobile alarm, and the corresponding alarm linkage will be carried out according to the setting.

- (1) The mobile alarm detection function is enabled by default. Drag the left mouse button in the video screen to draw the area to detect the mobile alarm. Click [Delete Region] to

delete the mobile alarm detection area.

- (2) Set the mobile alarm sensitivity, the higher the value, the more sensitive the mobile alarm detection.
- (3) The user can set the [Schedule] as required, and only detect the alarm within the set date and time period.
- (4) Set [Linkage Mode] to realize the alarm linkage after triggering the alarm, such as [Alarm Output], [Linkage Snap], etc.
- (5) Click [Save] to save the corresponding parameter settings, and click [Copy To...] copy the parameters of the current port number to other port numbers. Click [Cancel] to restore the last saved parameter.

### Event Management - > Mask

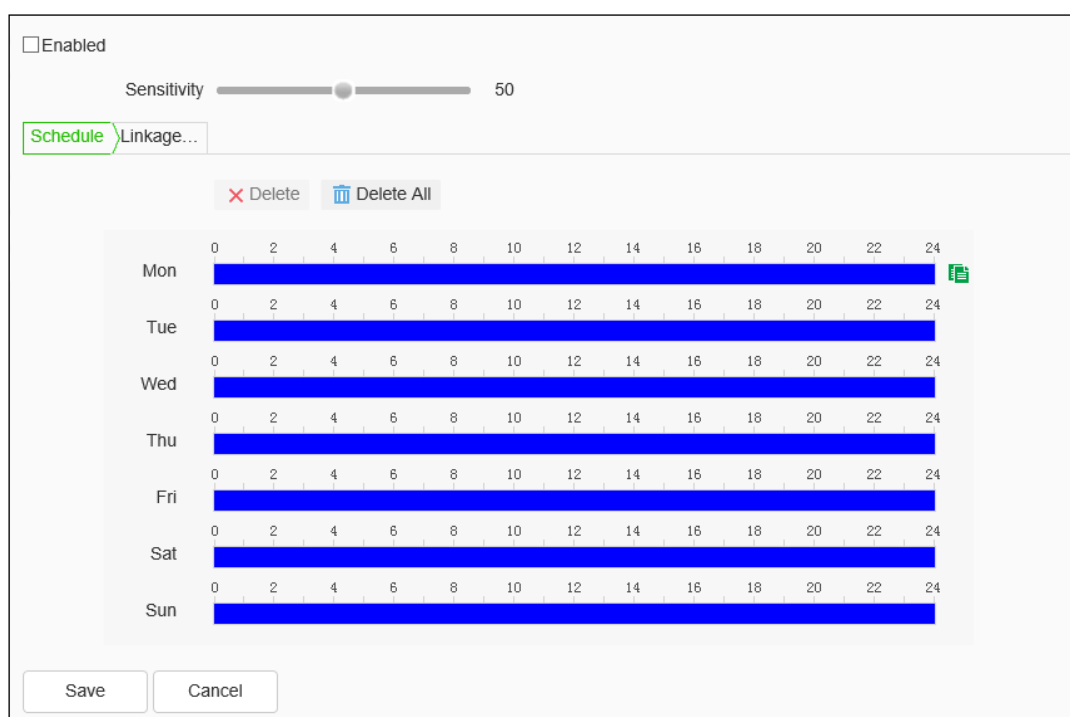

Fig.5.11.1.4 Mask setting interface

After the occlusion alarm is turned on, when the image in the video screen is blocked,

the alarm situation will be detected according to the sensitivity.

- (1) Check the [Enable] check box to turn on the video blocking alarm detection function, and uncheck to turn off the video blocking alarm detection function.
- (2) Set the video occlusion alarm sensitivity, the higher the value, the more sensitive the video occlusion alarm detection.
- (3) The user can set the [Schedule] as required, and only detect the alarm within the set date and time period.
- (4) Set the [Linkage Mode] to realize the alarm linkage after triggering the alarm, such as [Alarm Output], [Link Snapshot], etc.
- (5) Click [Save] to save the corresponding parameter settings, and click [Copy To...] copy the parameters of the current port number to other port numbers. Click [Cancel] to restore the last saved parameter.

### Event Management - > Other Alarms

<input checked="" type="checkbox"/> Event	Send To Server	Send Email	Alarm Output
<b>Storage Error</b>			
<input checked="" type="checkbox"/> Disk Full	<input checked="" type="checkbox"/>	<input checked="" type="checkbox"/>	Not Select...
<input checked="" type="checkbox"/> Disk R/W Error	<input checked="" type="checkbox"/>	<input checked="" type="checkbox"/>	Not Select...
<b>Abnormal network</b>			
<input checked="" type="checkbox"/> IP Address Conflict			Not Select...
<input checked="" type="checkbox"/> MAC address co...			Not Select...
<input checked="" type="checkbox"/> FTP server exce...	<input checked="" type="checkbox"/>	<input checked="" type="checkbox"/>	Not Select...

Save Cancel

Fig.5.11.1.5 other alarms

Some models support abnormal alarm. For exception types, you can select [Disk Full], [Disk R/W Error], [IP Address Conflict], [MAC Address Conflict], and set [Common Link] and

[Alarm output].

In [Common Link], you can set [Send To Server ]and [Send Email]. ([IP Address Conflict] and [MAC Address Conflict] cannot be set.)

[Alarm Output] the alarm output port number can be selected.

## **Event Management - >Temperature and humidity alarm. (Some models support this function).**

When user select [Temperature and humidity alarm] in [Peripheral type], this interface can be set. (User can set peripherals in [Configuration] - [System] - [Serial Port] - [Serial Port Set] - [Work Mode], choose [peripherals], and select [Temperature and humidity alarm] in [peripheral type]). User needs to check [enable] to open [Temperature and humidity alarm] function, and then, setting interval, temperature threshold, humidity threshold, schedule, link type, etc.

## **5.12 Smart surveillance (VCA)**

### **5.12.1 Create Rule**

## Create Rule -> Event Set

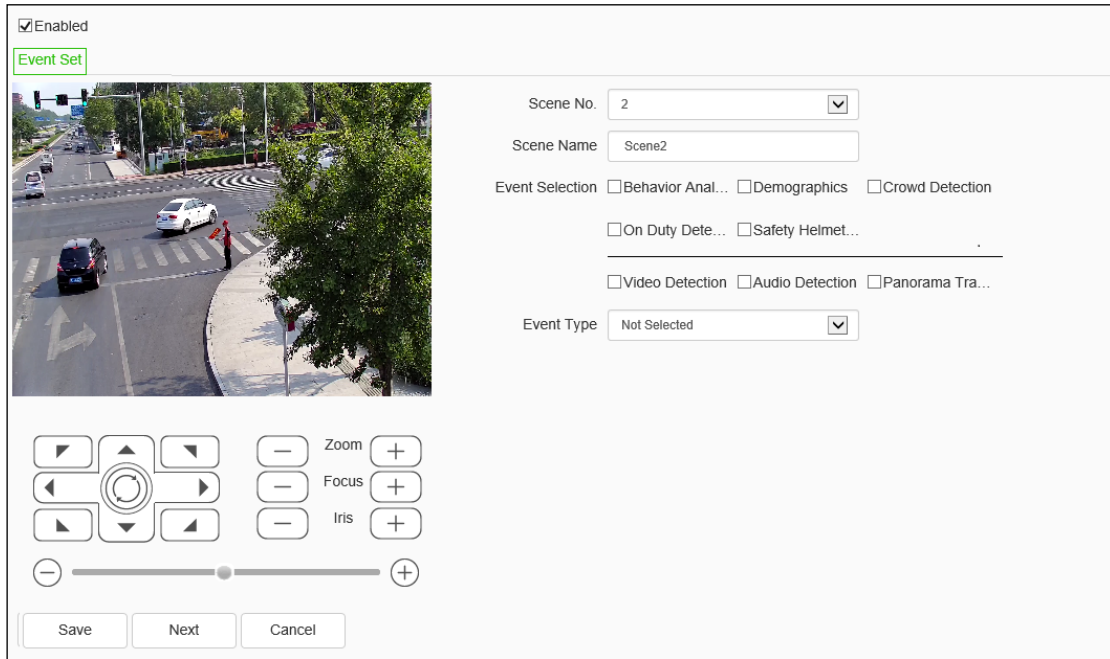

Fig.5.12.1.1 Event Set interface

[Enable]: enables or disables the intelligent analysis function of the current channel.

Description: When the AEW speed dome starts the intelligent analysis, the speed dome will scan the surrounding to revise the orientation automatically to promote the tracking accuracy.

[Scene number]: The scene number stands for different scene, can set total 16 scene, the number range is from 1 to 16. Different scenes can be set through the dome camera control menu at the left bottom.

[Scene Name]: The name of the scene can be defined by users themselves.

[Event set]: the device supports a variety of algorithms, such as behavior analysis, crowd aggregation, face detection, number of people statistics, and on duty detection, which are mutually exclusive. Only one of them can be enabled. Some devices support face detection,

population statistics, on duty detection algorithm, video diagnosis, audio anomaly detection, etc.

**Notes:**

(1) Interfaces and menus of different model may be different due to different functions they support, please refer to actual interfaces.

(2) Some algorithms are mutually exclusive with other algorithms, and the other algorithms can be enabled at the same time.

(3) Select the corresponding algorithm in [Event Type] and set the parameters of the algorithm.

**Arithmetic - Behavior Analysis**

[Behavior Analysis]: The algorithm includes tripwires, double tripwires, perimeter, items left over, items lost, wandering, running, heat map. [Save]: save all the settings.  
[Next] go into [Alarm Setup].

[Save]: save all the settings.

[Next] go into [Alarm Setup].



## Arithmetic - Behavior Analysis - Tripwire

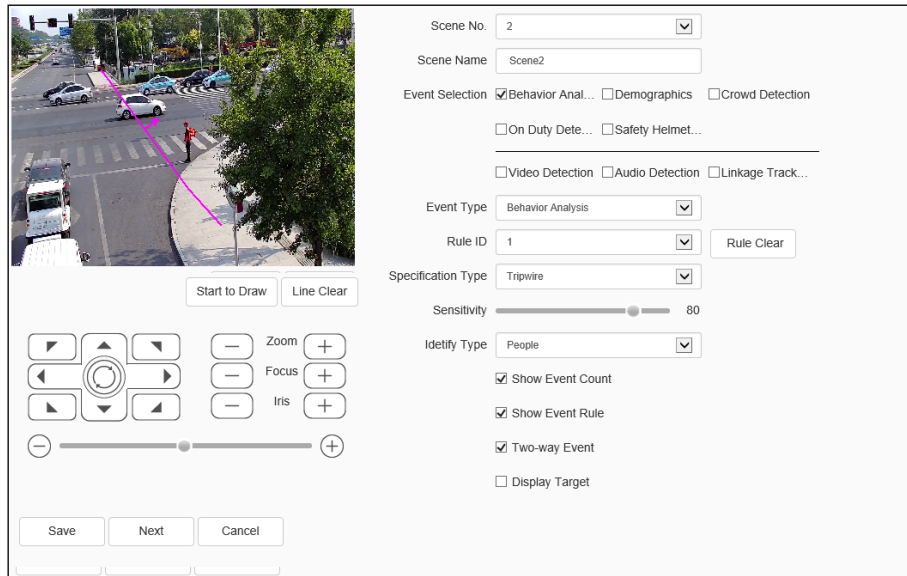

Fig.5.12.1.2 tripwire setting interface

(1) Select rule number, [Event Set] tripwire, and check [Valid].

(2) Draw rule line, the arrow of line means direction of prohibit crossing.

(3) Set whether the alarm statistics are displayed, display the alarm rules, whether two-way alarm and display the target.

(4) Save all the settings.

**Note:** When the alarm target track crosses the trip wire, it will alarm.

## Arithmetic - Behavior Analysis - Double Tripwire

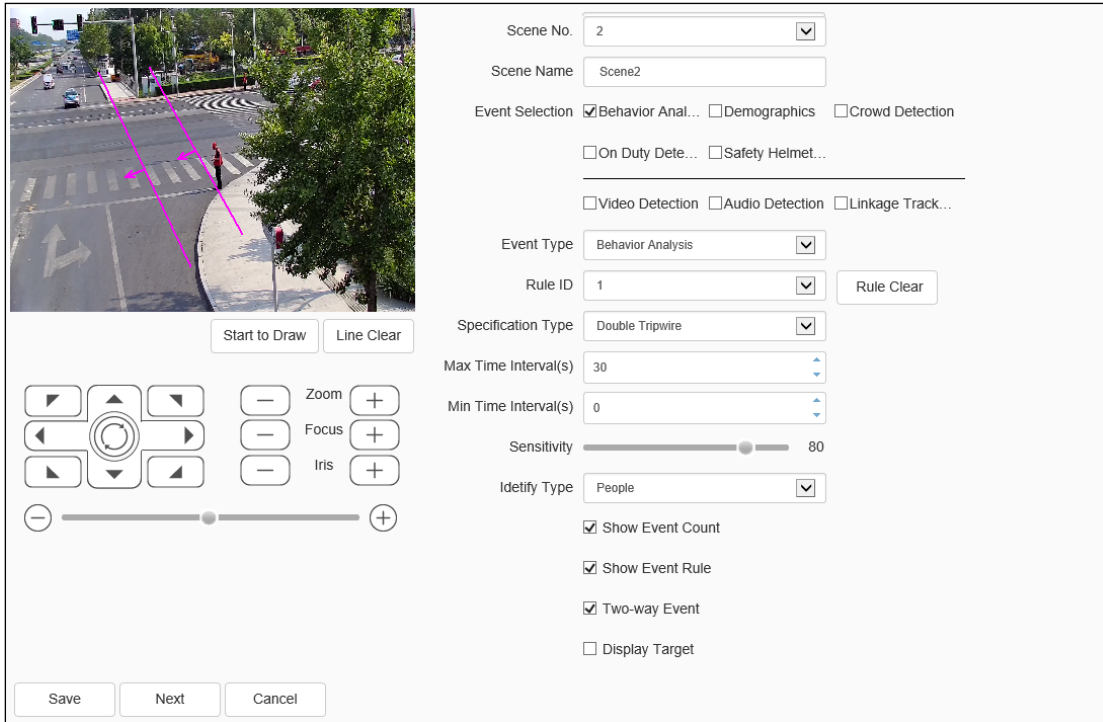

Fig.5.12.1.3 double tripwire setting interface

- (1) Select rule number, [Event Set] intrusion detection, and check [Valid].
- (2) Draw the detection area.
- (3) Select detection mode, [in] it will trigger alarm when object go in detection area; [out] it will trigger alarm when object go out detection area; [Intrusion] it will trigger alarm when object stay in detection area until reach [Invasion Time].
- (4) Set up the type of alarm recognition. It is recommended to be human by default.
- (5) Set whether the alarm statistics are displayed, display the alarm rules, whether two-way alarm and display the target.
- (6) Save all the settings.

**Note:** the alarm will occur when trip wire 1 and trip wire 2 are triggered continuously within the minimum and maximum time interval of line crossing.

### Arithmetic - Behavior Analysis - Perimeter

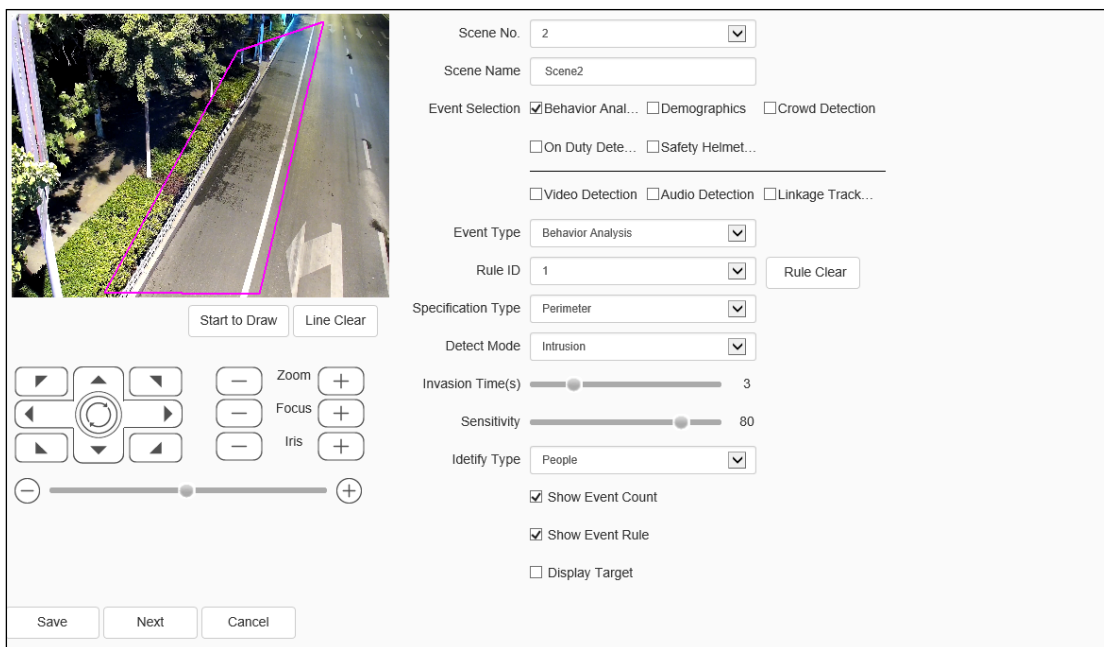

Fig.5.12.1.4 perimeter setting interface

- (1) Select rule number, [Event Set] intrusion detection, and check [Valid].
- (2) Draw the detection area.
- (3) Select detection mode, [in] it will trigger alarm when object go in detection area; [out] it will trigger alarm when object go out detection area; [Intrusion] it will trigger alarm when object stay in detection area until reach [Invasion Time].
- (4) [Invasion Time] setup invasion time of object stay in detection area; it will trigger alarm when over the time.
- (5) Set up the type of alarm recognition. It is recommended to be human by default.

(6) Save all the settings.

### Arithmetic - Behavior Analysis - Object Abandone]

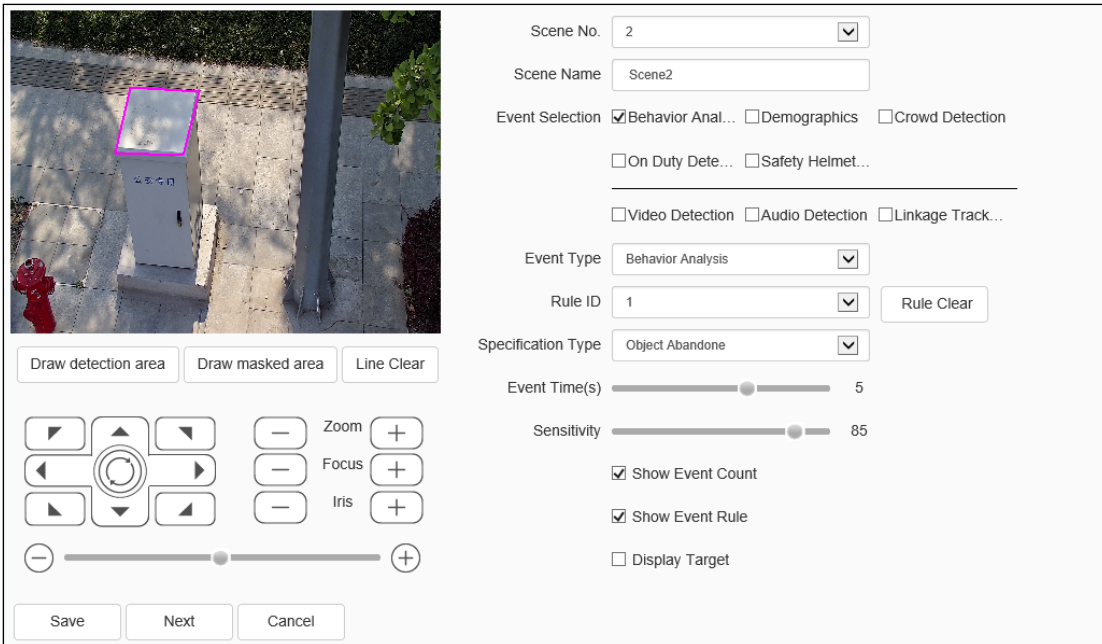

Fig.5.12.1.5 Object Abandone setting interface

(1) Select rule number, [Event Set] items abandon, and check [Valid].

(2) Draw detection area, please notice the detection area shouldn't overlap when [Items Abandon] and [Missing Object Detection] are enable at same time.

(3) [Alarm Time] setup alarm time of object stay in detection area; it will trigger alarm when over the time.

(4) Save all the settings.

**Note:** The alarm will occur after the still target appears in the area and reaches the set alarm time.

## Arithmetic - Behavior Analysis - Missing Object Detection

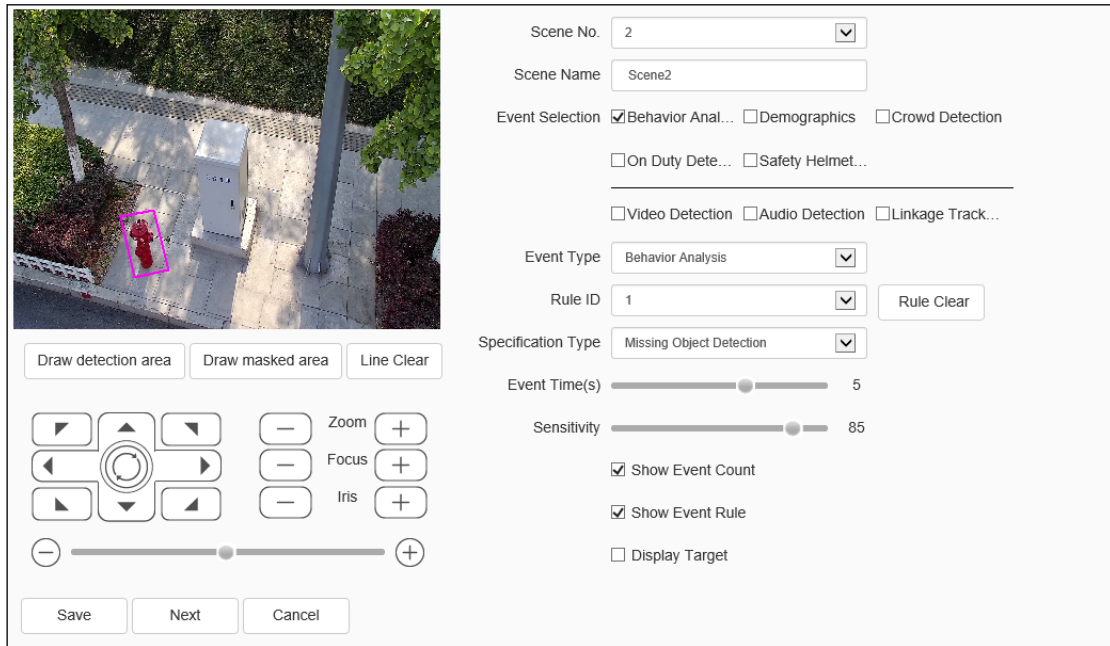

Fig.5.12.1.6 Missing Object Detection setting interface

- (1) Select rule number, [Event Set] missing object detection, and check [Valid].
- (2) Draw detection area, please notice the detection area shouldn't overlap when [Items Abandon] and [Missing Object Detection] are enable at same time.
- (3) [Alarm time] setup alarm time of object lost in detection area; it will trigger alarm when over the time.
- (4) Save all the settings.

**Note:** The alarm will occur when the target disappearing time in the area reaches the set alarm time.

## Arithmetic - Behavior Analysis - Loiter

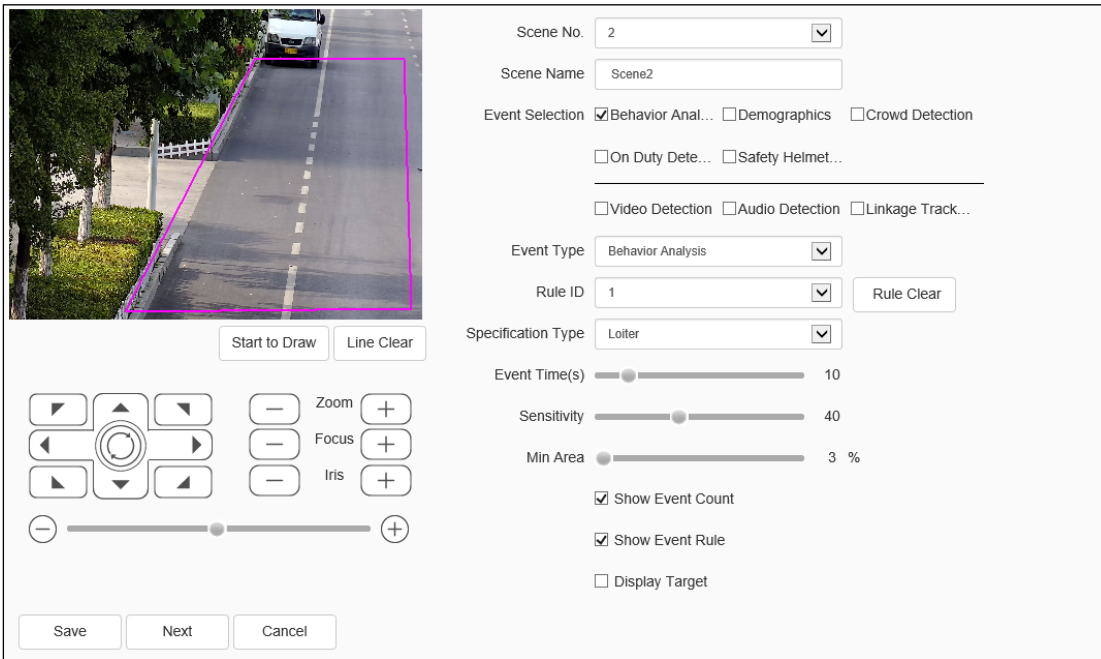

Fig.5.12.1.7 Loiter setting interface

(1) Choose [Rule ID] => [Loiter] => [Valid]

(2) Draw detection area on the image.

(3) Setup alarm time, alarm when the object keep loitering to this alarm time.

(4) Setup min area, alarm when the object's motion area is equal to or greater than this min area.

(5) Setup sensitivity, great are more sensitive.

(6) Save all the settings

**Note:** The alarm will occur when the moving target continuously reaches the set alarm time in the area or the moving range reaches the set minimum area.

## Arithmetic - Behavior Analysis - Running

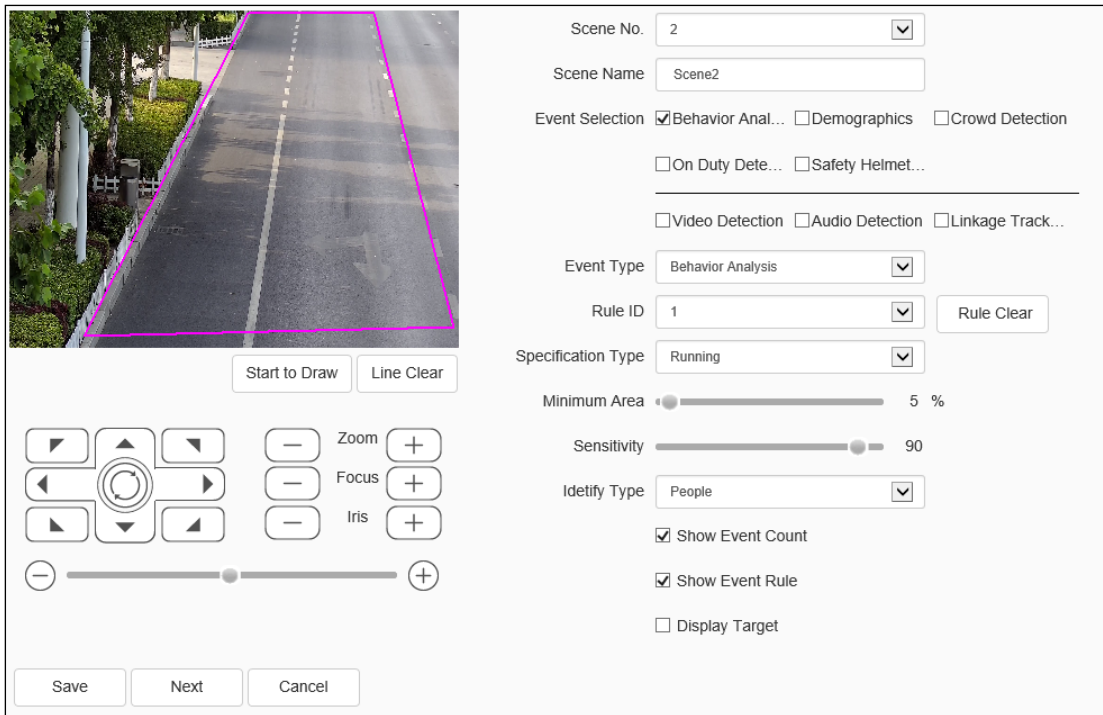

Fig.5.12.1.8 running setting interface

(1) Choose [Rule ID] => [Running] => [Vaild].

(2) Draw detection area on the image.

(3) Setup min area, alarm when the object's running area is equal to or greater than this min area.

(4) Save all the settings.

**Note:** The alarm will occur when the speed of moving target in the area is greater than the set moving distance per second

## Event Type - Behavior Analysis - heat map

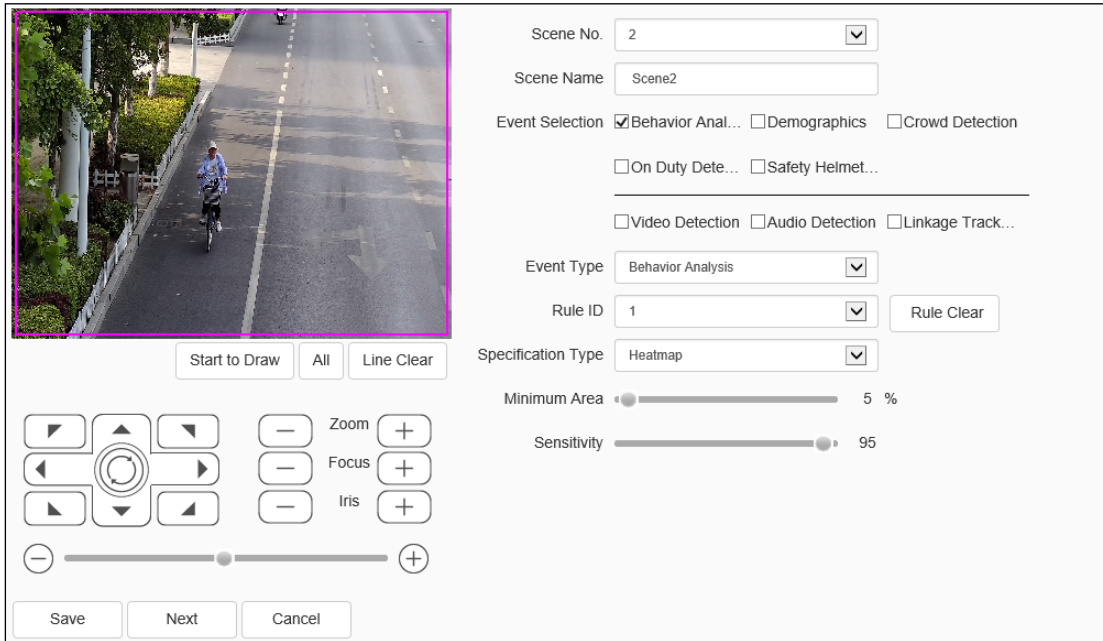

Fig.5.12.1.9 heat map setting interface

- (1) Select the rule number, the event is set to heat map, select the effective enable the rule.
- (2) Draw the heat map detection area.
- (3) Setup min area, alarm when the object's running area is equal to or greater than this min area.
- (4) Set whether the alarm statistics are displayed, display the alarm rules, whether two-way alarm and display the target.
- (5) Save all the settings.



## Behavior analysis - Linkage tracking

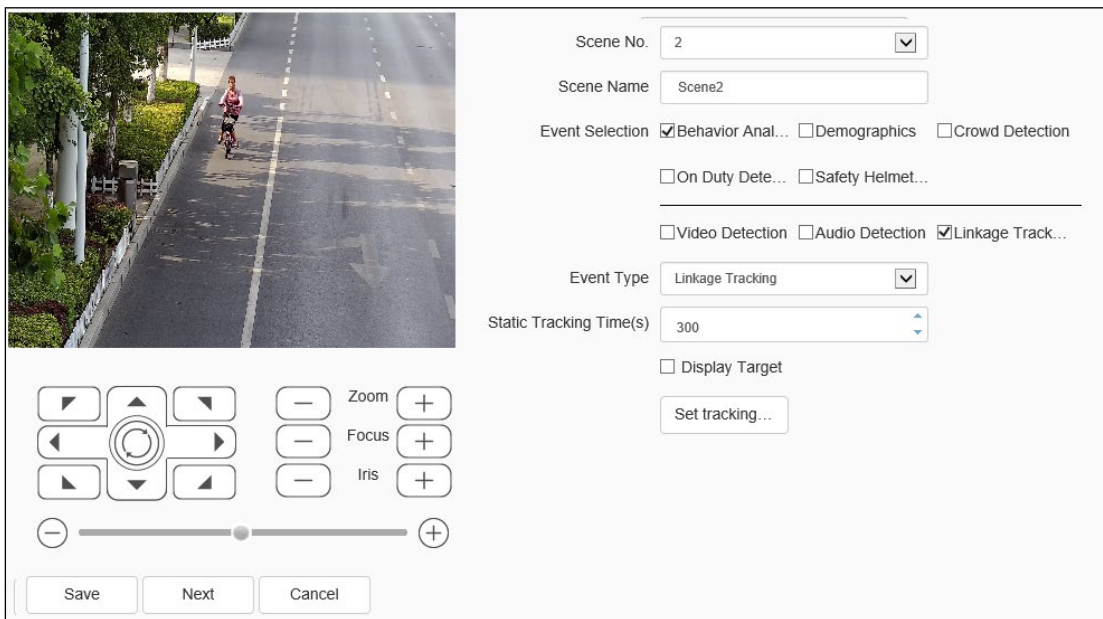

Fig.5.12.1.10.1 Linkage tracking setting interface

(1) Check the behavior analysis and linkage tracking simultaneously and when the target triggers the behavior analysis alarm, it will follow the tracking action. Select the behavior analysis and intelligent tracking in the algorithm configuration and then set the corresponding settings; the behavior analysis setting is the same as above and the intelligent tracking setting is as following.

(2) Set the longest tracking time (second): it indicates the duration of the dome camera for tracking the target and the default longest time is 300 seconds. When set to 0s, the dome camera keeps tracking until the target disappears.

(3) Set the needed tracking rate manually and confirm a suitable rate of the target on the screen by adjusting the rate. When tracking, it will track the target as per this magnification; click the tracking rate setting button to save the setting.



Fig.5.12.1.10.2 tracking time setting interface

(4) Set whether to display the target or not.

(5) After clicking the save button, click the next step, and it will link to the alarm setting interface.

### Arithmetic - Demographics

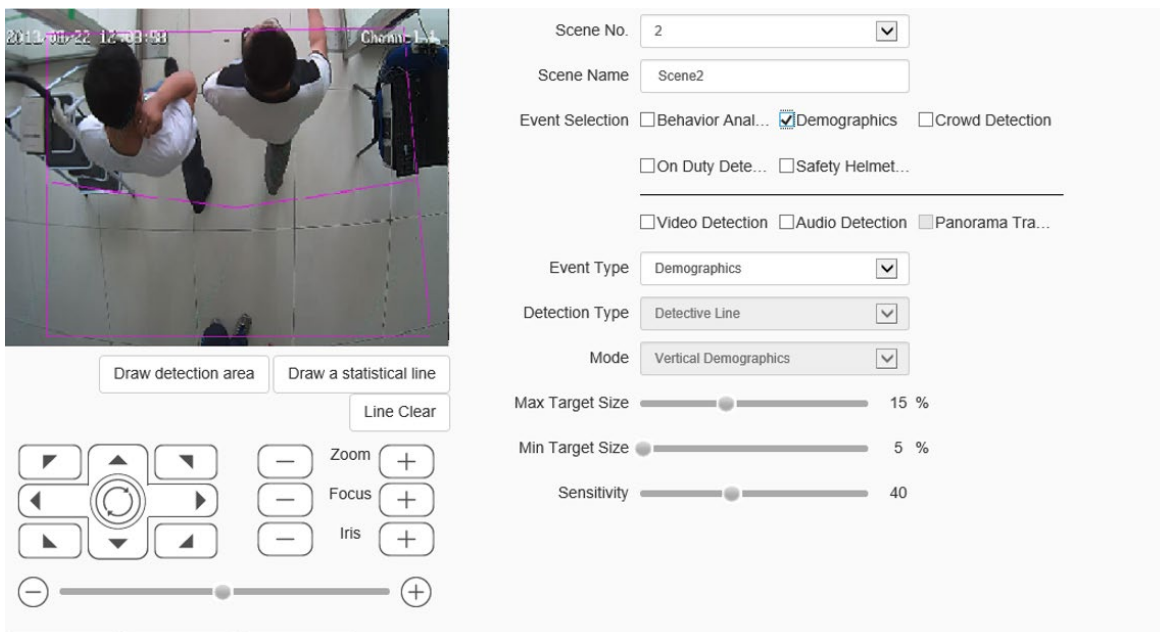

Fig.5.12.1.12 Demographic setting interface

- (1) Draw People Counting area, double click to finish.
- (2) Draw Counting line, it will detect in or out.
- (3) Setup Max and Min target size, the size means target width compare to screen width.
- (4) Setup sensitivity, the bigger value relate to higher sensitivity. Note: Only vertical statistics are supported.

### Enable Arithmetic - Crowded Detection

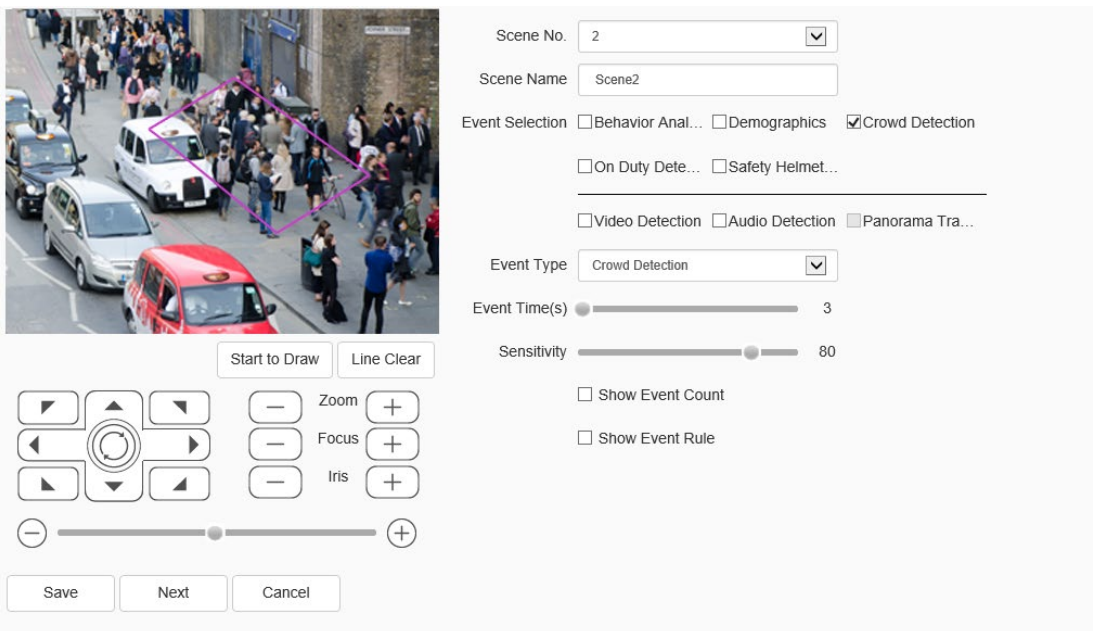

Fig.5.12.1.13 Crowded Detection Setting Interface

- (1) Draw the crowd gathering detection area.
- (2) Set the alarm time, which indicates that the alarm will be triggered after the alarm status continues to reach this time specified.
- (3) Click save after setting.

Note: the alarm will occur when the intensity of moving targets in the detection area

exceeds the set value

Sensitivity represents the proportion of moving targets in the area of detection area.

### Event Type - On Duty Detection

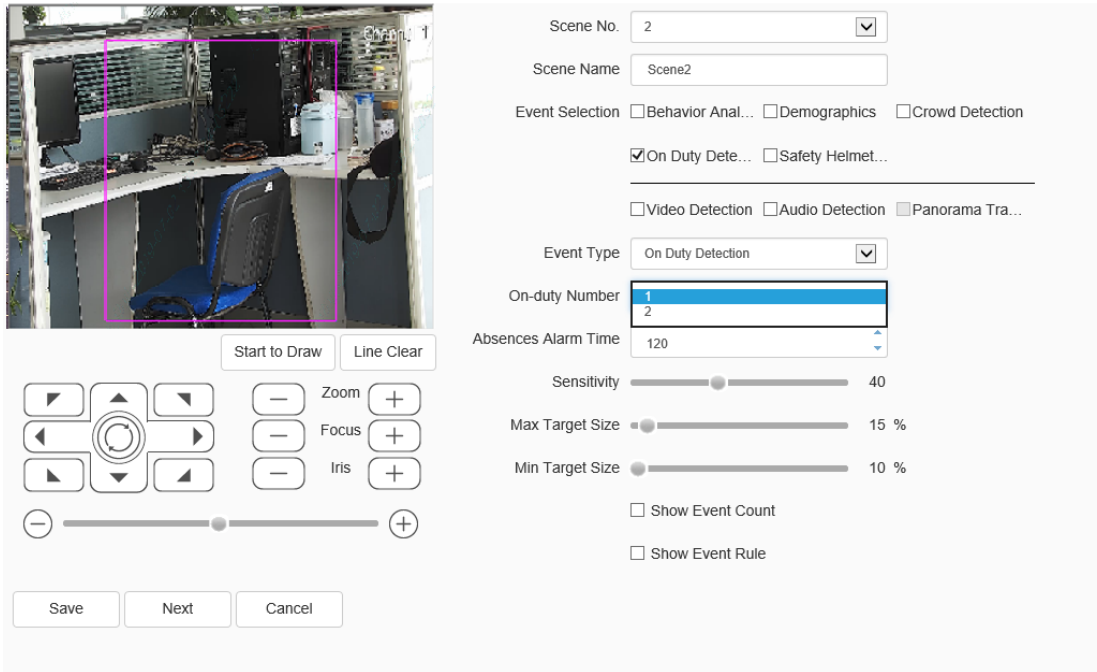

Fig.5.12.1.14 On Duty Detection Setting Interface

- (1) Draw duty detection area.
- (2) Setup the number of duty.
- (3) Setup alarm time, alarm when the pertion keep leaving to this alarm time.
- (4) Setup sensitivity, the bigger value relate to higher sensitivity.
- (5) Setup Max and Min target size, the size means target width compare to screen width.

### Event Type - Video Detection

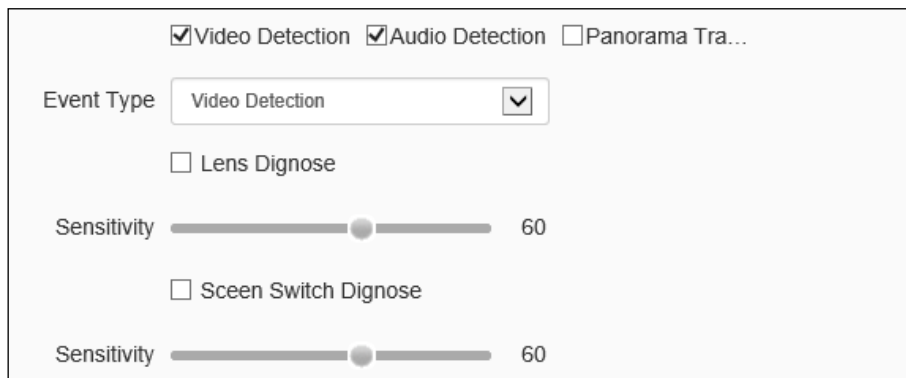

Fig.5.12.1.17 Video Detection Setting Interface

- (1) Set whether to enable virtual focus diagnosis and scene transformation diagnosis.
- (2) Set the sensitivity. The larger the value is, the more sensitive it is.
- (3) Click save after setting.

#### Event Type - Audio Detection

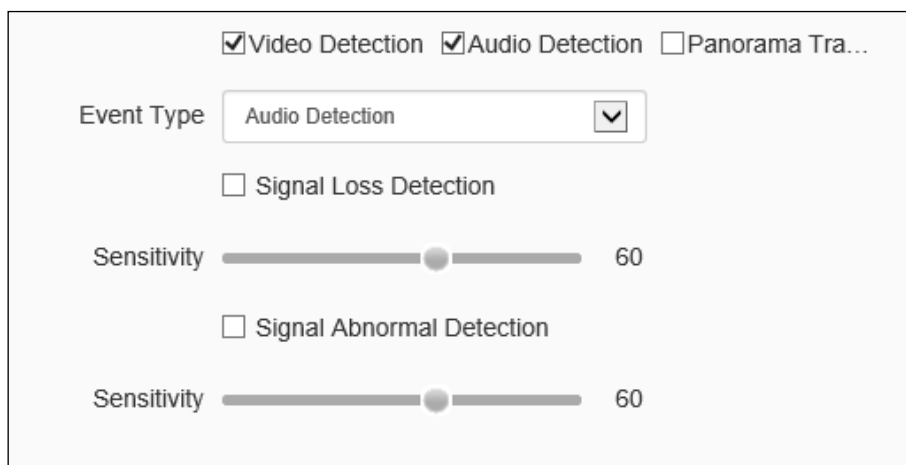

Fig.5.12.1.18 Audio Detection Setting Interface

- (1) Set whether to start the signal lost detection and signal abnormality detection.
- (2) Set the sensitivity: the higher the value, the higher the sensitivity and the false detection will also increase.

(3) Set the sound intensity threshold: it means when the sound exceeds the set threshold, it is determined as the audio abnormality.

(4) The real time sound volume can display the set sound intensity threshold; when there's an audio signal, it also can display the audio amplitude.

(5) After clicking the save button, click the next step, and it will link to the alarm setting interface.

**Notes:** After setting details, set [Schedule] and [Linkage Mode] to intelligent analysis and alarm linkage. Click [Next] to enter the [Schedule] setting.

### Event Type - Panorama Tracking

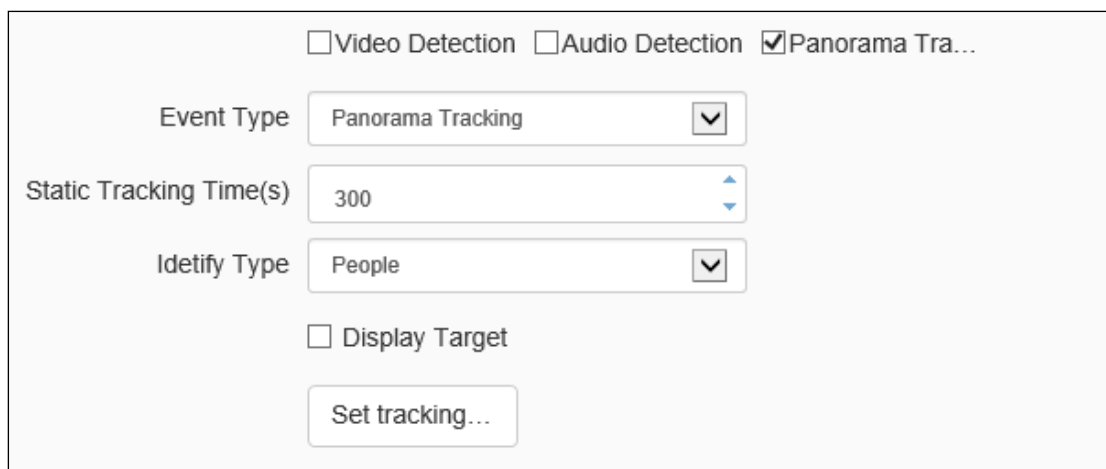

Video Detection    Audio Detection    Panorama Tra...

Event Type:

Static Tracking Time(s):

Identify Type:

Display Target

Fig.5.12.1.19 Panorama Tracking setting interface

(1) Set the longest tracking time (second): it indicates the duration of the dome camera for tracking the target and the default is 300 seconds. When set to 0s, the dome camera keeps tracking until the target disappears.

(2) Set the needed tracking rate manually and confirm a suitable rate of the target on the screen by adjusting the rate. When tracking, it will track the target as per this magnification; click the tracking rate setting button to save the setting.

(3) Set whether to display the target or not.

(4) After clicking to save, then click the next step to enter the cruise mode settings.

### Create Rule->[Schedule]



Fig.5.12.1.20 schedule setting interface

Set the effective time of the rule. By default, it is 24 hours a day. Click the blue bar to modify the deployment time,

Click the green " copy to " button on the right to select the day of the week see

Fig.6.5.2.2.2 and then click save.

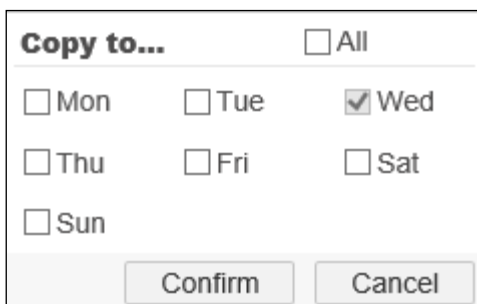

Fig.5.12.1.21 Copy to interface

Click [Next] to enter [Linkage Mode] setting.

### Create Rule-> [Linkage Mode]

Common Link	Alarm Output	Link Rec	Link Snap
<input type="checkbox"/> Laser	<input type="checkbox"/> 1	<input type="checkbox"/> [1] Channel 1	<input type="checkbox"/> [1] Channel 1
<input type="checkbox"/> White Light Flashing <input type="button" value="v"/>	<input type="checkbox"/> 2		<input type="checkbox"/> FTP
<input type="checkbox"/> Sound Warning <input type="button" value="v"/> <input type="button" value="🔊"/>			<input type="checkbox"/> Email

Fig.5.12.1.22 Linkage Mode setting interface

Set the alarm linkage function when the alarm occurs. For example: [Alarm Output], [Link Rec], [Linkage Snap], and etc.

Click [Save] to save the parameter settings. Click [Cancel] to restore the last saved parameter.

## 5.12.2 Shield Area

**Attention: When the original scene is changed, it needs to configure the shield area again.**

Scene No.    Enabled

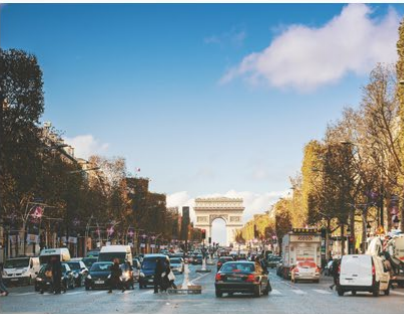

Fig.5.12.2 Shield Area setting interface



Shield Area refers to reducing the false alarm rate by drawing the area in the scene and not using the target in the drawn area as the warning target. For example: lights, branches and so on.

Support the blocking area settings of intelligent analysis scene and alert scene, select the corresponding scene, tick Enable, draw the area in the screen and click Save to take effect.

This function can only be set in intelligent monitoring mode.

### 5.12.3 Cruise Set

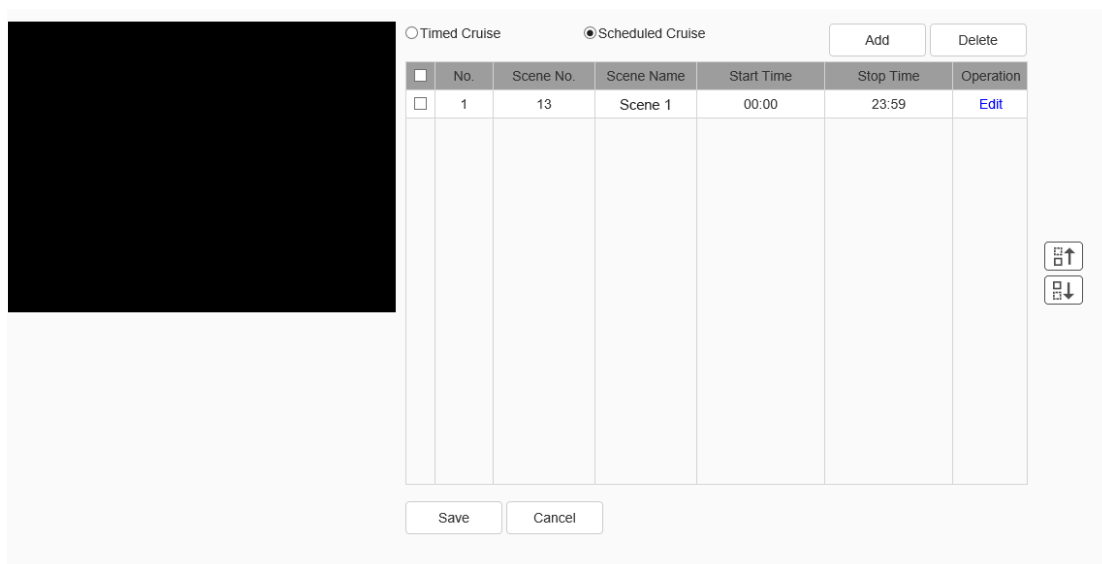

Fig.5.12.3.1 Timed Cruise setting interface

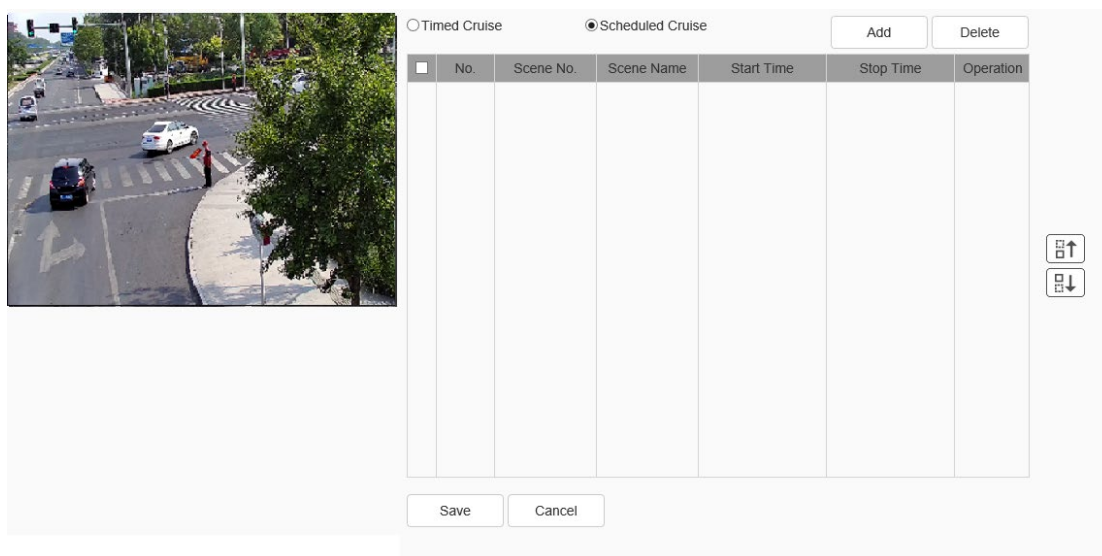



Fig.5.12.3.2 Scheduled Cruise setting interface

The cruise mode is used to set the scene cruise of different intelligent analysis, and can be set to be timed cruise and cruise by time period. The cruise can be adjusted order through the up  and down  button on the interface.

[Add]: It is used to add the cruise scene.

[Delete]: After checking the appropriate scene, delete the selected cruise scene.

[Save]: Save the set cruise parameter.

### Timed cruise

[Standing time (s)]: Set the standing time of the cruise scene.

### Scheduled Cruise

[Start time]: Set the cruise start time of the scene.

[End time]: Set the cruise end time of the scene.

## 5.12.4 Advance Params

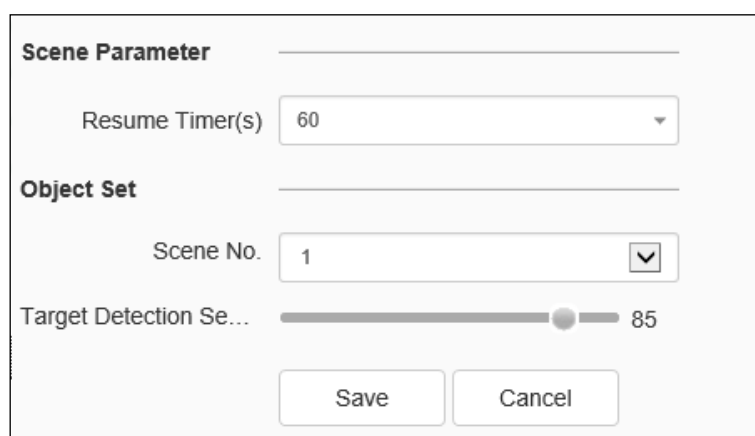

The screenshot shows a dialog box titled "Advance Params". It is divided into three main sections:

- Scene Parameter:** A dropdown menu for "Resume Timer(s)" is set to "60".
- Object Set:** A dropdown menu for "Scene No." is set to "1".
- Target Detection Se...:** A horizontal slider is positioned at "85".

At the bottom of the dialog, there are two buttons: "Save" and "Cancel".

Fig.5.12.4 Advance Params

**Notes:** [Advance]: is only available for company engineer to setup.

Upon the completion of the setting of the above parameters, click [Save] to save and enable; Click [Reset] to restore parameters saved last time.

## 5.12.5 Intelligent Retrieval

### Intelligent Retrieval->Heatmap

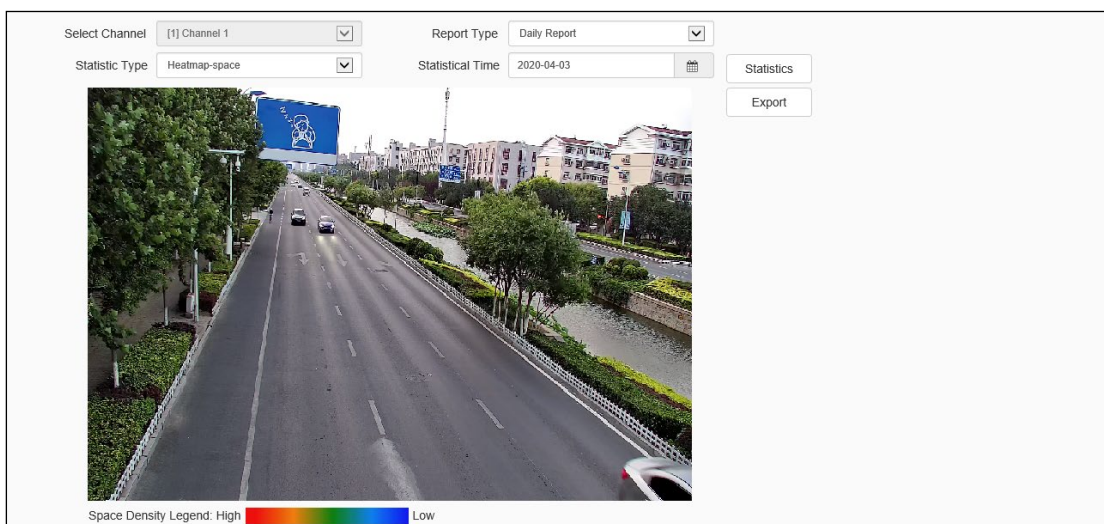

Fig.5.12.5.1 Heatmap setting interface

By setting the [Condition], click [Statistics] to display the statistics result in the column [Result]. Click [Export] to save the statistical data in the local. (Some models support this function).

### Intelligent Retrieval->Face Statistics

This interface is used for statistics and exporting face images. (If using statistical function, the camera should install micro SD card.)

After setting up statistic parameters, click the [Statistics] button to start statistics. Point [list] and [pie chart] switch the statistics result. Point the [Export] button to export the statistics from the camera.

By setting the [Condition], click [Statistics] to display the statistics result in the column [Result]. Click [Export] to save the statistical data (.xls) in the local. (Some models support this function).

## 5.12.6 Online VCA Log

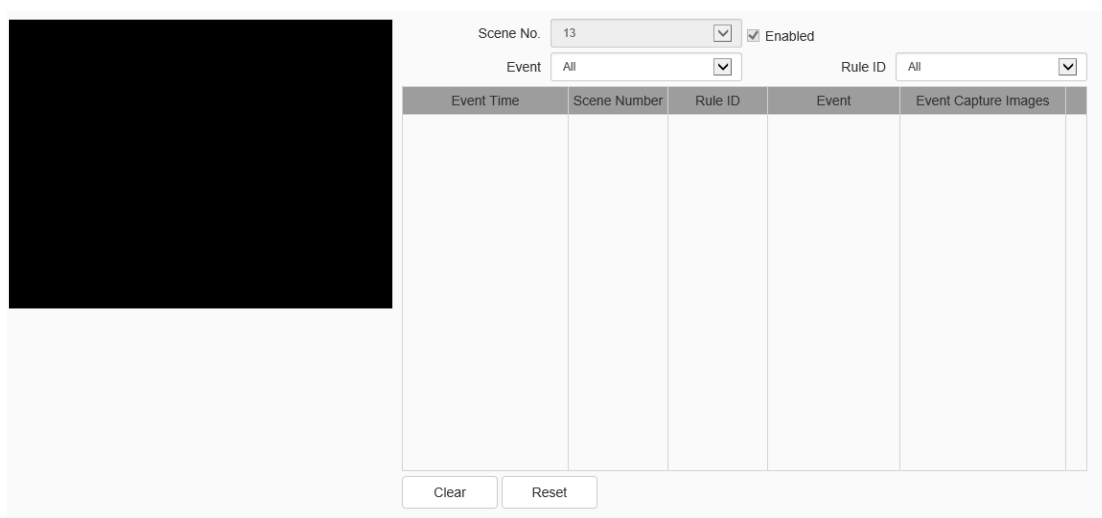

Fig.5.12.6 Online VCA Log setting interface

[Scene NO.]: check alarm information about the related scene.

[Event]: check certain or all VCA events alarm information.

[Rule ID]: check certain or all rule's alarm information.

[Reset]: Reset the alarm times of the event, it will restart from 1 when alarm occurs.

[Clear]: clear all alarm information from current list.

Note: Click the path of the alarm snapshot image to preview the local image. This is a real-time function. After switching the interface, the information will be cleared and recorded again. This interface only displays the latest alarm information. If you want to view more pictures, you need to view them in the path of smart analysis snapshot.

## 5.13 Smart surveillance (Thermal Bi-spectrum AI PTZ camera part)

Thermal Bi-spectrum AI PTZ camera support temperature and smoke detection, which is often used in forest fire prevention and temperature anomaly alarm.

## 5.13.1 Algorithm configuration

There are two channels in thermal Bi-spectrum AI PTZ camera, channel 1 algorithm see section 5.12 intelligent monitoring (VCA), which supports behavioral analysis, gathering, vehicle license plate recognition, people counting, duty detection, carport guard, helmet detection, linkage tracking, video diagnosing and audio abnormal detection. Channel 2 is thermal imagery channel, which supports behavioral analysis, temperature detection, pyrotechnic detection, panoramic tracking and linkage tracking. While pyrotechnic detection is chosen, it is recommended that visible light should be zoomed to the recommended perspective, as shown below:

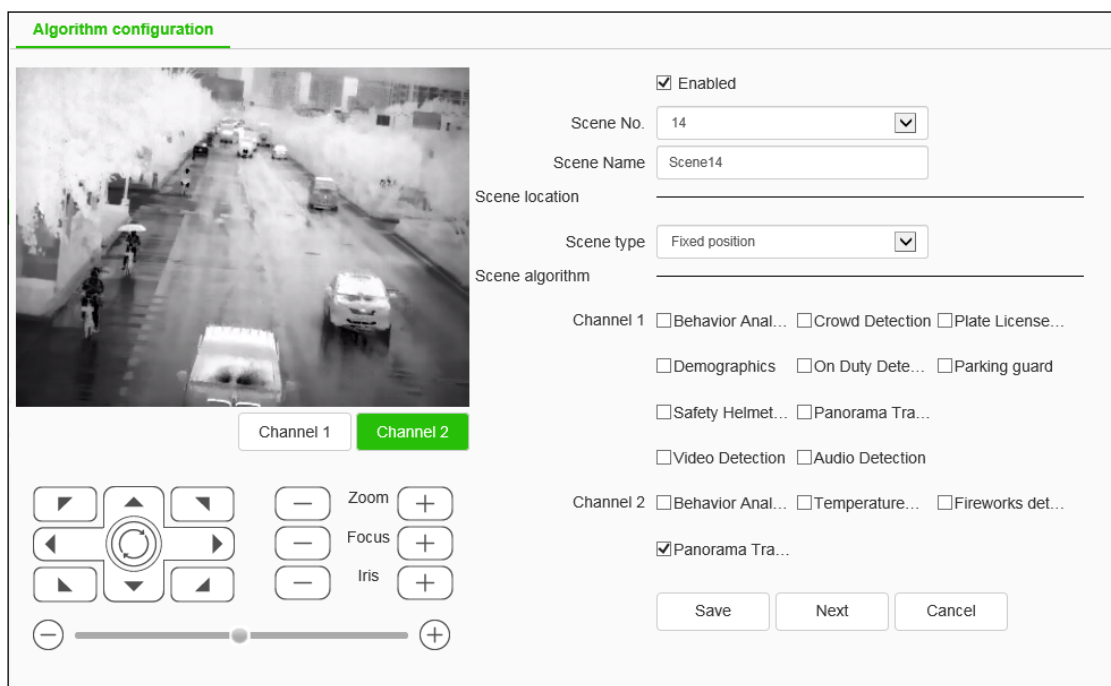

Fig.5.13.1.1 Thermal equipment algorithm configuration page

### Algorithm configuration->scene position->permanent position

Permanent position: aim to the condition of Intelligent Analysis Algorithm for Static Scene. Support the algorithm of behavioral analysis, pyrotechnic detection, panoramic

tracking.

### Algorithm configuration->scene position->area scanning

Area scanning: scanning based on the set horizontal and vertical scanning boundary, retention time and step mode. Support the algorithm of temperature and pyrotechnic detection, as shown below:

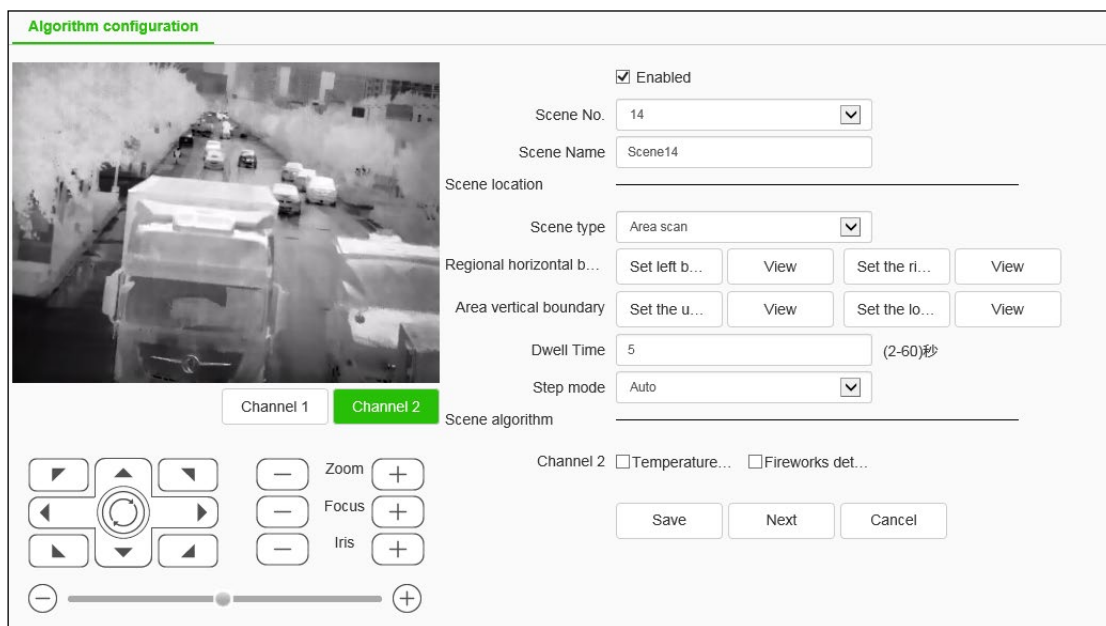

Fig.5.13.1.2 Algorithm configuration - the scene of area scanning

## 5.13.2 Create Rule

The event argument configuration of channel 1 see section 5.12 intelligent monitoring (VCA).

The event argument configuration of channel 2 is as follow:

### Event Setting->Behavioral Analysis

Thermal imagery channel supports the algorithm of tripwire, double tripwire, perimeter

and so on. Concrete operations are as follow:

### Event Setting-> Behavioral Analysis -> Tripwire

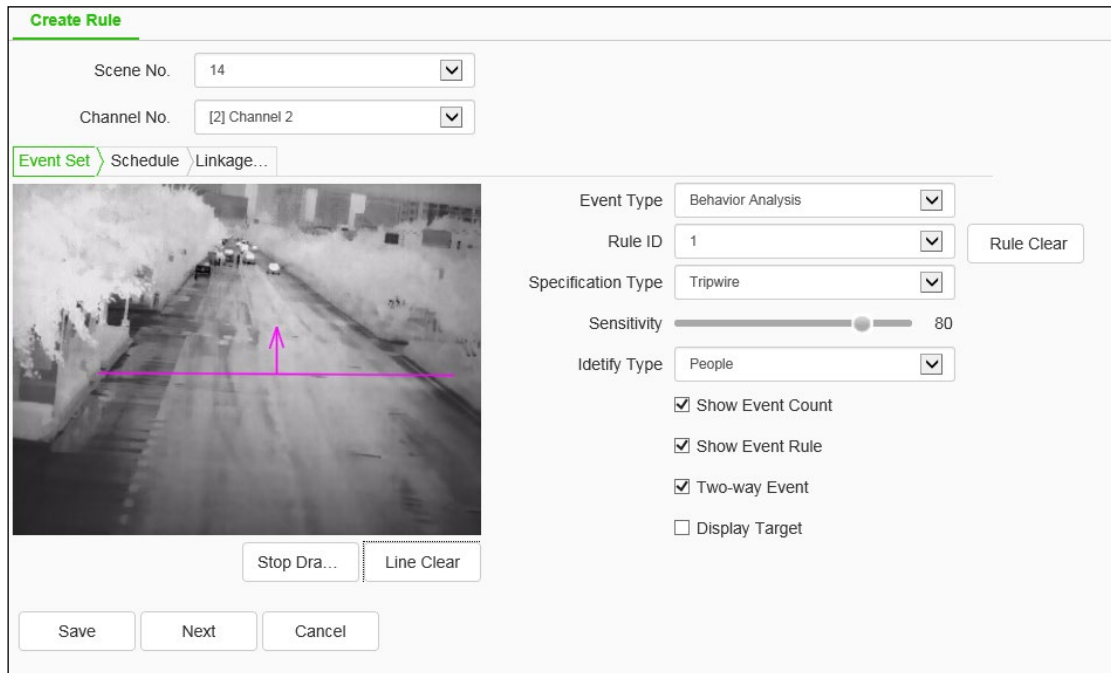

Fig.5.13.2.1 Tripwire Setting

- (1) Select the scene number and channel number, set the specification type to tripwire.
- (2) Click the "Start Draw" button to draw the tripwire rule line, on which the arrow indicates the direction of the forbidden crossing, click the "Stop Draw" button to cease, click the "Line Clear" to clear the rule line.
- (3) Set default recommended identification type to people.
- (4) Set the detection sensitivity, the greater the number, the more sensitive the device is.
- (5) Set "Show Even Count", "Show Event Rule", "Two-Way Event" and "Display Target".
- (6) Click Save when settings are complete.

Note: Alarm when target trajectories cross with the tripwire.

## Event Setting->Behavioral Analysis->Double Tripwire

The screenshot shows the 'Create Rule' configuration window. At the top, 'Scene No.' is set to 14 and 'Channel No.' is set to [2] Channel 2. The 'Event Set' tab is active. The video preview shows a street with two horizontal purple lines and arrows pointing right, indicating the direction of the forbidden crossing. The settings panel on the right is configured as follows:

- Event Type: Behavior Analysis
- Rule ID: 1
- Specification Type: Double Tripwire
- Max Time Interval(s): 30
- Min Time Interval(s): 0
- Sensitivity: 80
- Identify Type: People
- Show Event Count
- Show Event Rule
- Two-way Event
- Display Target

Buttons at the bottom include 'Save', 'Next', and 'Cancel'. A 'Stop Dra...' button is located below the video preview, and a 'Line Clear' button is to its right. A 'Rule Clear' button is located to the right of the 'Rule ID' dropdown.

Fig.5.13.2.2 Double Tripwire Setting

- (1) Select scene number and channel number, and set the specification type to double tripwire.
- (2) Draw 2 rule lines, on which the arrow indicates the direction of the forbidden crossing, the direction of the two lines should be the same, alarm when passing two lines continuously within a specified time.
- (3) Set maximum and minimum time interval(s), which represents the time range for continuous crossing of two rule lines.
- (4) Set the detection sensitivity, the greater the number, the more sensitive the device is.
- (5) Set default recommended identification type to people.
- (6) Set "Show Even Count", "Show Event Rule", "Two-Way Event" and "Display Target".
- (7) Click Save when settings are complete.

Note: alarm when trigger tripwire 1 and tripwire 2 continuously at minimum and maximum time intervals.



## Event Setting->Behavioral Analysis->Perimeter

The screenshot shows the 'Create Rule' configuration window for a Perimeter event. The 'Event Set' tab is active, and a video feed displays a street scene with a red rectangular perimeter drawn around a group of vehicles. The configuration parameters on the right are as follows:

- Scene No.: 14
- Channel No.: [2] Channel 2
- Event Type: Behavior Analysis
- Rule ID: 1
- Specification Type: Perimeter
- Detect Mode: Intrusion
- Mode of intrusion alarm: Alarm on departure from test area
- Invasion Time(s): 3
- Sensitivity: 80
- Identify Type: People
- Show Event Count
- Show Event Rule
- Display Target

Buttons at the bottom include 'Save', 'Next', and 'Cancel'. A 'Rule Clear' button is also present next to the Rule ID field.

Fig.5.13.2.3 Perimeter Setting

- (1) Select scene number and channel number, and set the specification type to perimeter.
- (2) Click the "Start Draw" button to draw the perimeter detection area, click the "Stop Draw" button to cease, and click the "Line Clear" to clear the detection area.
- (3) Select detect mode; the entry mode indicates that the target will trigger the alarm when comes into the area, the departure mode indicates that the target will trigger the alarm when leaves the area, and the intrusion mode indicates that the target will trigger the alarm when stays in the detection area for a fixed time.
- (4) Set the mode of intrusion alarm; alarm on departure from test area indicates that alarm will remove after the target leave the test area in (2), and alarm on departure from video area indicates that alarm will remove after the target leave the video area.
- (5) Set invasion time, which indicates that the alarm will be triggered when the target come in the test area for that duration.
- (6) Set the detection sensitivity; the greater the number, the more sensitive the device is.
- (7) Set default recommended identification type to people.
- (8) Click Save when settings are complete.

## Event Setting->Behavioral Analysis->Linkage Tracking

The screenshot shows a 'Create Rule' configuration window. At the top, 'Scene No.' is set to 14 and 'Channel No.' is set to [2] Channel 2. Below this, the 'Event Set' section is active. It includes a video preview of a street scene with cars. To the right of the preview, the 'Event Type' is 'Linkage Tracking', 'Static Tracking Time(s)' is 300, and 'Identify Type' is 'Cars'. There are two checkboxes: 'Display Target' is checked, and 'Visible light zoom to similar angle of view' is unchecked. A red tip message is visible: 'Tip: In order to ensure the timeliness and effect of tracking, close-up snapshot operations will not be performed'. At the bottom of the window are three buttons: 'Save', 'Next', and 'Cancel'.

Fig.5.13.2.4 Linkage Tracking Setting

- (1) Select scene number and channel number.
- (2) Check behavioral analysis and linkage tracking; when there is a target trigger behavior analysis alarm, the linkage tracking actions. Select behavioral analysis and linkage tracking in algorithm configuration, then set up accordingly, behavioral analysis settings as above; linkage tracking settings are as follows.
- (3) Set static tracking time (s), which represents the ball-head camera's tracking duration towards the target, defaults to 300 seconds. When set to 0 second, the camera will track until the target disappears.
- (4) Set default recommended identification type to people.
- (5) Set "Display Target".
- (6) Set "Visible light zoom to similar angle of view".
- (7) Click Save when settings are complete.

## Event Setting->Temperature Detection

Temperature detection supports temperature difference alarm, high temperature alarm, as follows:

**Create Rule**

Scene No.

Channel No.

**Event Set** | Schedule | Linkage...



Event Type

Temperature difference alarm

Temperature threshol...

High temperature alarm

High temperature thr...

Display the highest and lowest temperature position

Save Next Cancel

Fig.5.13.2.5 Temperature Detection Setting

- (1) The test area is full screen;
- (2) Temperature difference alarm: if the highest, and lowest temperature in the screen exceeding the set temperature difference threshold, it will be alarmed and uploaded.
- (3) High temperature alarm: if the highest temperature in the screen exceeding the set high temperature threshold, it will be alarmed and uploaded.
- (4) Waiting time for finding alert (s): the time duration of waiting when an alert occurs and stop scanning. Exceeding the waiting time, the tripod head will continue to scan the area.
- (5) Display the highest and lowest temperature position: Mark the highest and lowest temperature position on the screen.

### Event setting->fireworks detection

In the fireworks detection algorithm, it is suggested to zoom in the visible light to the

recommended angle of view.

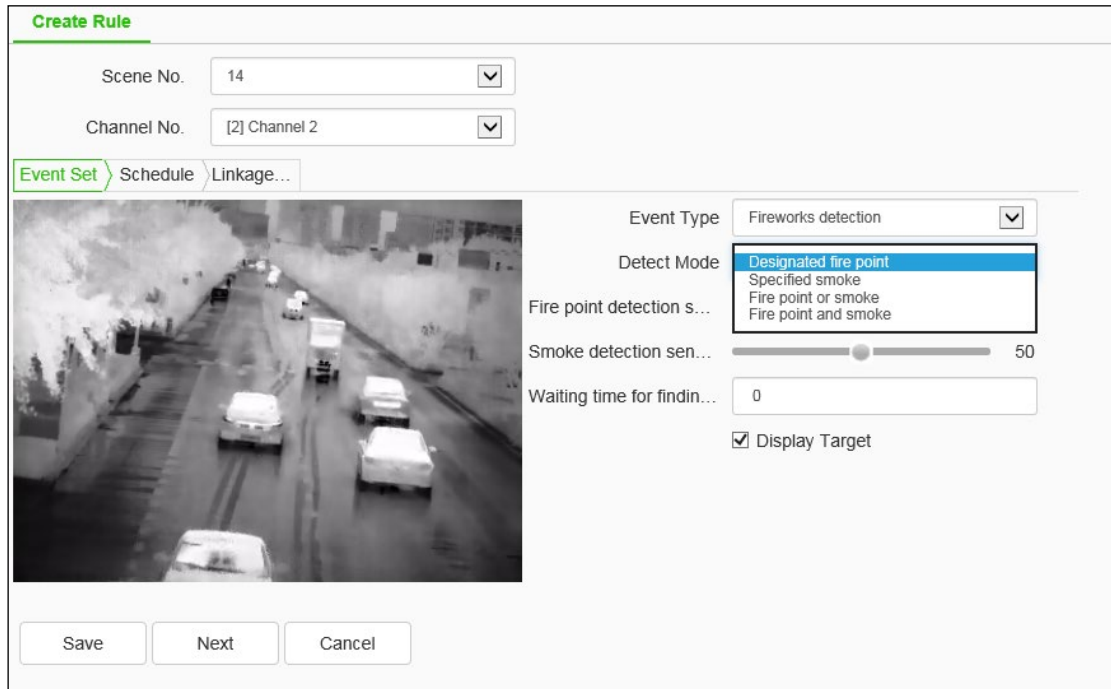

Fig.5.13.2.6 Fireworks Detection Setting

- (1) The test area is full screen.
- (2) Set detect mode, which include "Fire point or smoke", "Fire point and smoke", "Designated fire point", and "specified smoke". "Fire point or smoke" means when judged as fire point or smoke will alarm and upload alert; "fire point and smoke" means when fire and smoke are detected at the same time, it will alarm and upload alert; "designated fire point" means only detect the fire point, alarm and upload the alert when the fire point is found, and "specified smoke" means only detect smoke, alarm and upload alert when smoke is detected.
- (3) Fire point detection sensitivity; the higher the sensitivity, the higher the detection rate, and the higher the false alarm rate; the lower the sensitivity, the lower the detection rate and the lower the false alarm rate.

- (4) Smoke detection sensitivity, the higher the sensitivity, the higher the detection rate, the higher the false alarm rate; the lower the sensitivity, the lower the detection rate and the lower the false alarm rate.
- (5) Waiting time for finding alert (s): the time duration of waiting when an alert occurs and stop scanning. Exceeding the waiting time, the tripod head will continue to scan the area.

### Event Setting->Panoramic Tracking

The screenshot shows a 'Create Rule' configuration window. At the top, there are dropdown menus for 'Scene No.' (set to 14) and 'Channel No.' (set to [2] Channel 2). Below this is an 'Event Set' section with a video preview of a street scene. To the right of the preview are the following settings:

- Event Type: Panorama Tracking (dropdown)
- Static Tracking Time(s): 300 (spinners)
- Identify Type: People (dropdown)
- Display Target
- Visible light zoom to similar angle of view

A red tip message is located at the bottom right: "Tip: In order to ensure the timeliness and effect of tracking, close-up snapshot operations will not be performed". At the bottom of the window are three buttons: 'Save', 'Next', and 'Cancel'.

Fig.5.13.2.7 Panoramic Tracking Setting

- (1) Select scene number and channel number.
- (2) Set static tracking time (s), which represents the ball-head camera's tracking duration towards the target, defaults to 300 seconds. When set to 0 second, the camera will track until the target disappears.
- (3) Set default recommended identification type to people.
- (4) Set "display target".
- (5) Set "visible light zoom to similar angle of view".
- (6) Click Save when settings are complete.

## Event Setting->Defense-Placing Time

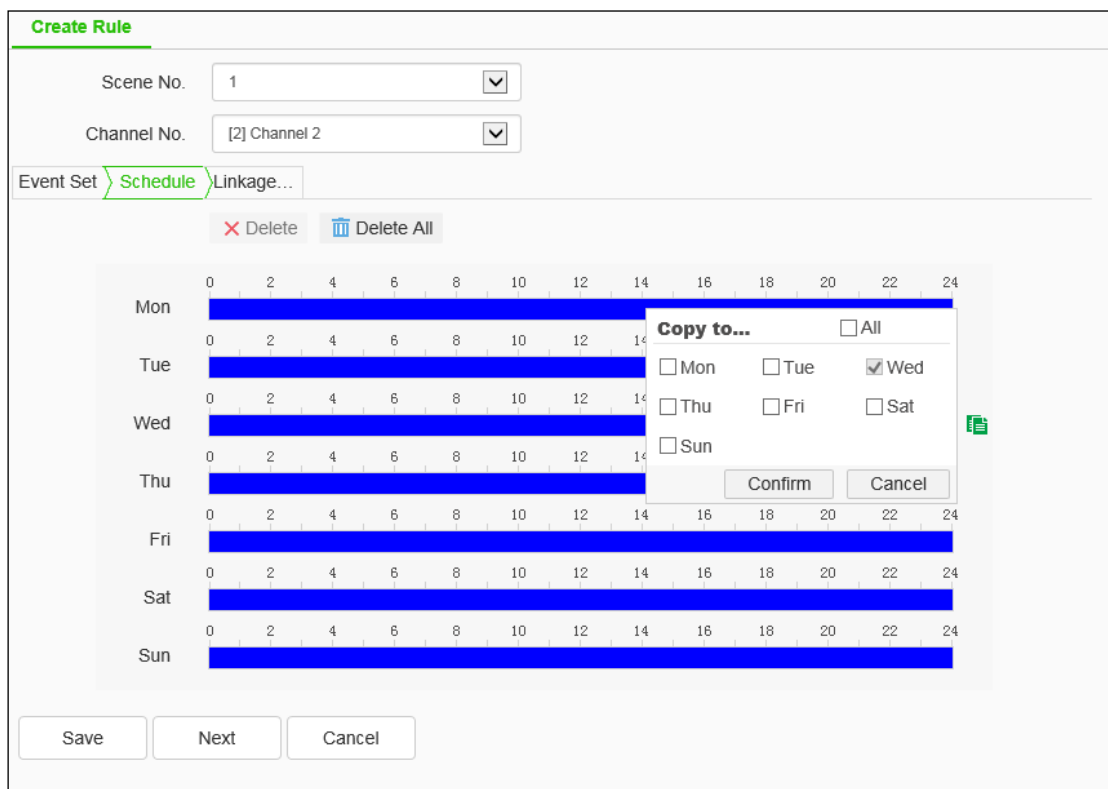

Fig.5.13.2.8 Defense-Placing Time Setting

Set the rule valid time, default the defense-placing time to 24 hours a day. Click the blue bar to modify the time, click the "Copy to" button on the right to choose the date. Click Save when settings are complete.

## Event Setting->Linkage Mode

Common Link	Alarm Output	Link Rec	Link Snap
<input type="checkbox"/> Laser	<input type="checkbox"/> 1	<input type="checkbox"/> [1] Channel 1	<input type="checkbox"/> [1] Channel 1
<input type="checkbox"/> White Light Flashing <input type="button" value="v"/>	<input type="checkbox"/> 2	<input type="checkbox"/> [2] Channel 2	<input type="checkbox"/> [2] Channel 2
<input type="checkbox"/> Sound Warning <input type="button" value="v"/> <input type="button" value="audition"/>			<input type="checkbox"/> Close-up capturing Similar perspective <input type="button" value="v"/>
<input type="checkbox"/> Alarm light			<input type="checkbox"/> FTP
			<input type="checkbox"/> Email

Fig.5.13.2.9 Linkage Mode Setting

Set alarm linkage function when alert occurs, like "Common Link", "Alarm Output", "Link Rec", "Link Snap", etc. Click the audition button right side the warning sound, you can listen.

### Description:

#### Linkage Mode->Close-Up Capturing

- (1) This function means that when the visible light channel is captured, it can be pushed to a certain rate to snap.
- (2) It can be divided into 2 modes, similar perspective and self-adaption. Different algorithm types, support different patterns, please refer to the actual.
- (3) Similar perspective refers to capturing by zooming in the visible light channel to the similar perspective of the thermal image channel. Self-adaption means to calculate

the appropriate variable value in accordance with the target size, and zoom in the visible light to the appropriate position. When the user chooses the behavioral analysis linkage tracking, the close-up capture operation will not be performed in order to ensure the timeliness and effect of the tracking.

### 5.13.3 Shield Area

Thermal camera supports four shield area setting include scene, fire point detection, smoke detection, temperature detection. Descriptions are as follow:

#### Shield Area->Shielding Area of Scene

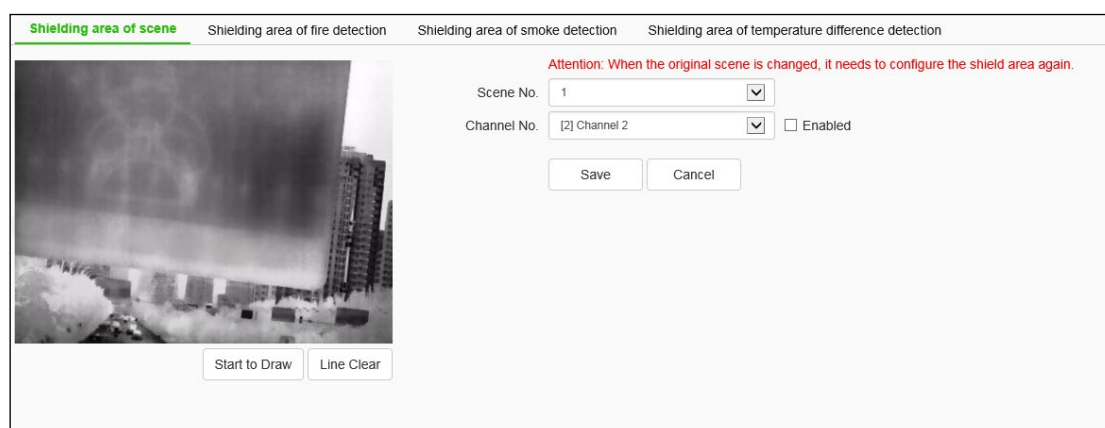

Fig.5.13.3.1 Shielding Area of Scene

Shielding area of scene is to reduce the false alarm rate by drawing the area in the scene which will not be taken as the alarm target, such as lamplight and trees, etc.

Each scene supports up to 8 shield areas, select the corresponding channel and channel number, check enabled, detect in the screen area, click save to take effect.

**Attention:** If the original monitoring scene changes, the shield area automatically fails and needs to be reconfigured. This function only supports settings in smart monitoring mode.



## Shield Area->Shielding Area of Fire Detection

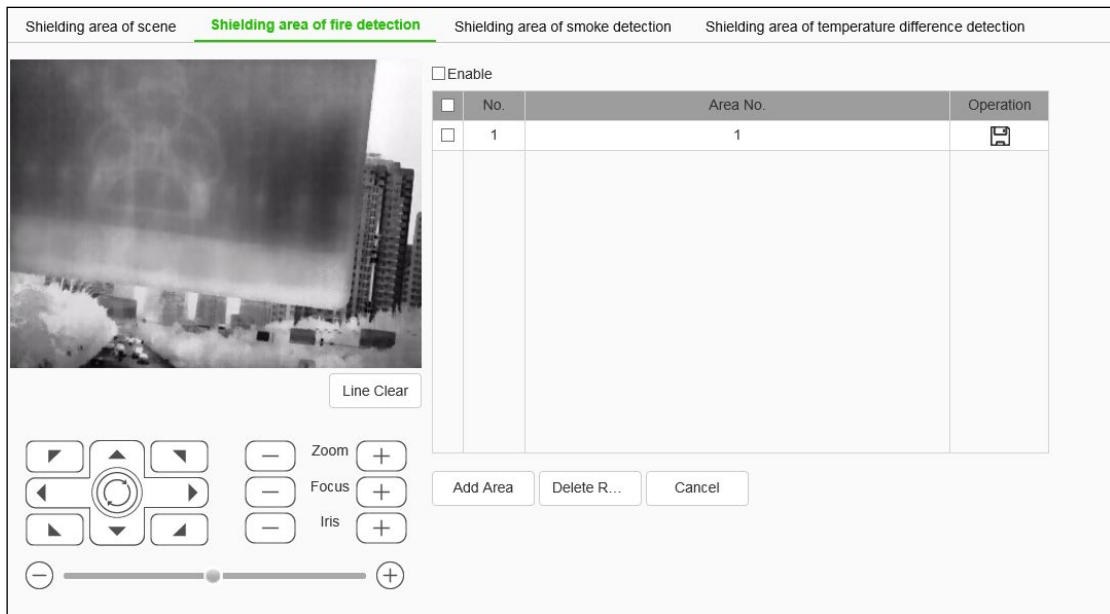

Fig.5.13.3.2 Shielding Area of Fire Detection

Shielding area of fire detection is to reduce the false alarm rate by drawing the area in the scene which will not be taken as the alarm target. Operating instructions are as follow:

- (1) Enable checkbox, and enable shielding area of fire detection.
- (2) Adjust the position of the drawing area by the directional key and draw the shielding area.
- (3) After drawing, click the "add area" button to complete the addition. To redraw, click the "line clear" button.
- (4) Click the "delete region" button to delete the shield area.
- (5) Each scene supports up to 48 shield areas.
- (6) Click the "reset" button to restore the last operation.

## Shield Area->Shielding Area of Smoke Detection

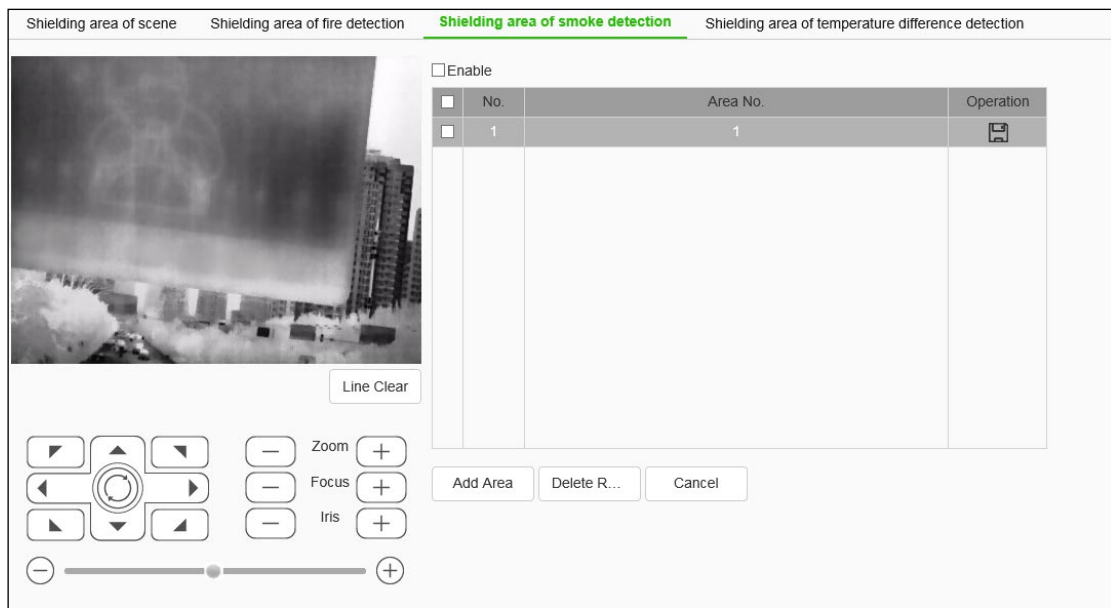

Fig.5.13.3.3 Shielding Area of Smoke Detection

Shielding area of smoke detection is to reduce the false alarm rate by drawing the area in the scene which will not be taken as the alarm target. Operation is the same as shielding area of fire detection.

## Shield Area->Shielding Area of Temperature Difference Detection

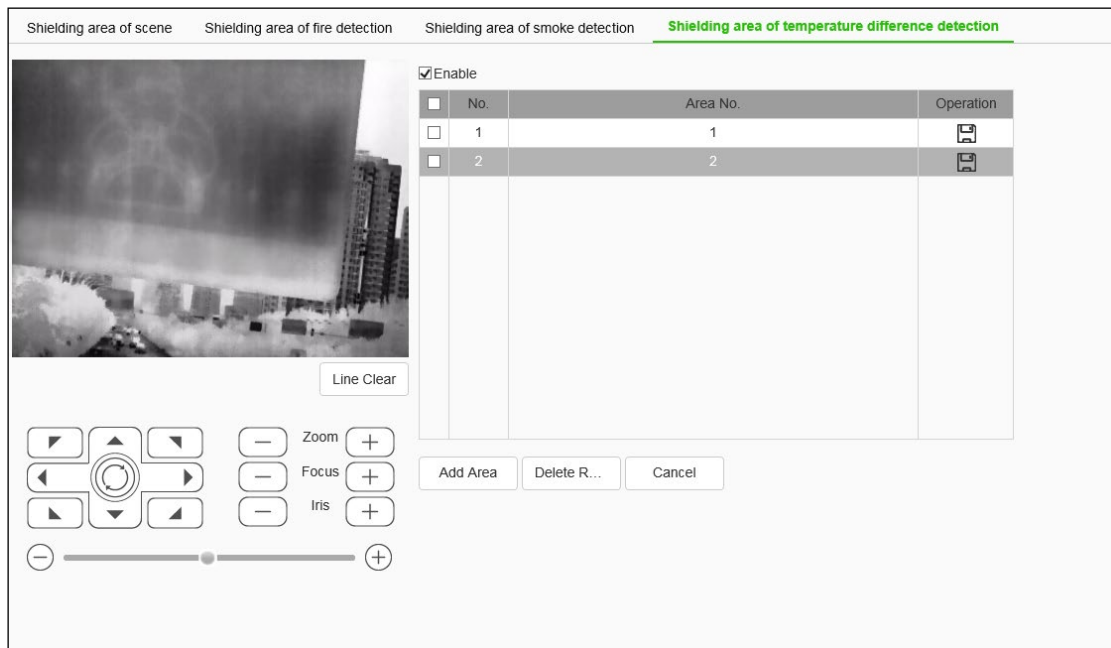

Fig.5.13.3.4 Shielding Area of Temperature Difference Detection

Shielding area of temperature difference detection is to reduce the false alarm rate by drawing the area in the scene which will not be taken as the alarm target.

### 5.13.4Cruise Set

See 5.12.3 Cruise Set.

### 5.13.5Advance Params

See 5.12.4 Cruise Set.

### 5.13.6VCA Report

See 5.12.5 VCA Report.

## 5.13.7 Online VCA log

See 5.12.6 Online VCA log.

## 5.14 Capture facial images

When the resource allocation is Face Snapshot, this menu will be displayed. In the menu, there are submenus of Snapshot Setting, Deployment Time and link mode.

### 5.14.1 Face Configuration

#### Face Configuration->Face Detection

Fig.5.14.1.1 Face Detection interface

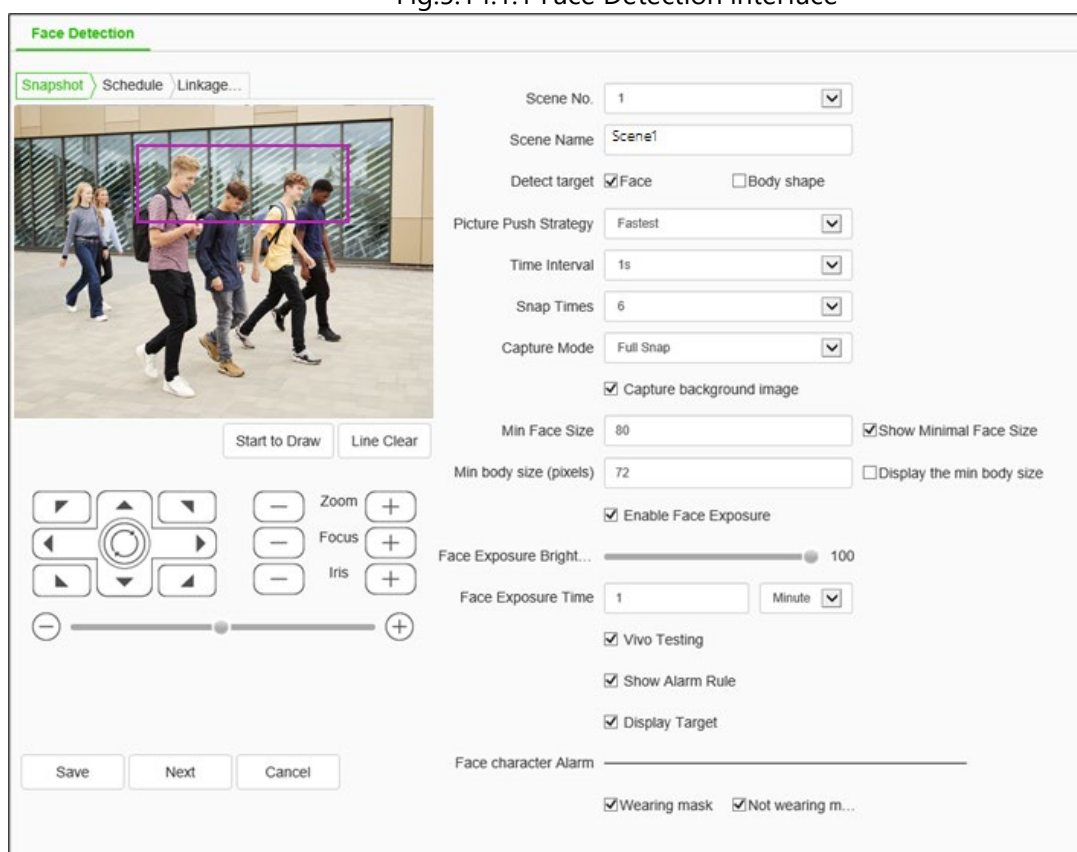

#### Face Detection - > Snapshot

Users set relevant parameters for snapping settings as needed, such as [Detection

Target], [push Strategy], [Snapshot Mode], and so on.

- (1) Check the [Detection Target] box. The device supports face and humanoid capture mode.
- (2) Set [Detect target][ Picture Push Strategy][ Snap Times][ Min body size (pixels)] and Setup minimal face size.(Different model may be different due to different arithmetic they support, please refer to actual interfaces)
- (3) If checked[Capture background image], When capturing a face / humanoid image, the background image can be captured at the same time.
- (4) If Check[Enable Face Exposure], the device supports face exposure, and parameter information such as [face exposure brightness] and [face exposure time] need to be set.
- (5) AS needed See Check [Vivo Testing] 、 [Show Alarm Rule]、 [Display Target].
- (6) Some devices support the mask algorithm and check the face attribute alarm as [Wearing mask/ Not wearing mask] so that the detection mode of the mask algorithm can be set.
- (7) Click save after setting.

**Description:**

- (1) [Picture Push Strategy] = >[Best]: it is necessary to screen out a small face map with the highest comprehensive quality score in this trajectory.
- (2) [Picture Push Strategy] = > [Fastest]: it is necessary to select a small face map that meets the comprehensive quality threshold in a short time to push.
- (3) [Capture Mode] = > [Full Snap]: it means not controlled by the security boundary and not filtered by the security boundary threshold. All pictures are sent to the push module by default.
- (4) [Capture Mode] = >[ High Quality]: it refers to filtering according to the default security

boundary threshold value of the system, and sending the filtered results to the push graph module.

(5) [Capture Mode]= > [User Defined]: filter according to the security boundary value set by user-defined, and send the filtered result to the push graph module.

(6) [Face Exposure Brightness] refers to the reference brightness of the face exposure. when the face is identified in the preview screen, the device automatically adjusts the face brightness according to the reference brightness value. the larger the face brightness value is, the brighter the whole preview screen is. The parameter should not be set too low or too high.

### **Face Detection - > Schedule**

The user can set the [deployment time] as required, and only detect the alarm within the set date and time period.

Click [save] to save the corresponding parameter settings.

Click [Cancel] to restore the last saved parameter.

Click  to copy the time set in the current time slot to other time slot.

### **Face Detection - >Linkage Mode**

Set the alarm link functions when warning condition occurs, such as [Alarm Output], [Record], [Snapshot], etc. (Link type supported by different models is slightly different, please refer to actual product)

Click [save] button to save the corresponding parameter settings.

Click [reset] will cause the parameters to be restored.

## Face Configuration-> Area Set

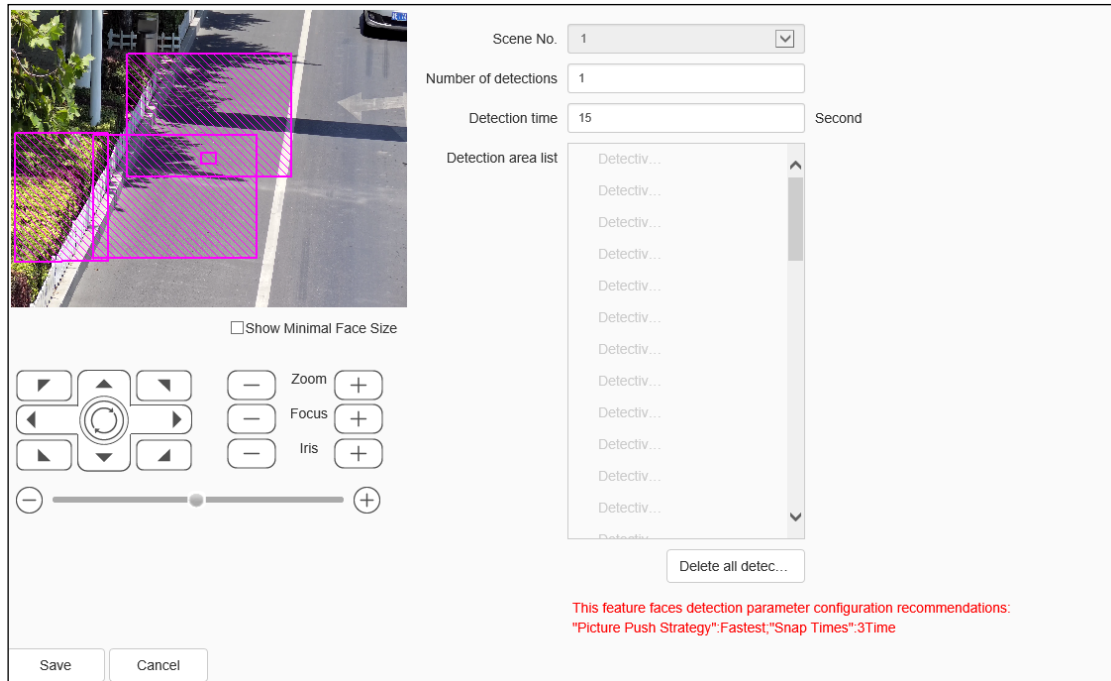

Fig.5.14.1.2 Area Set

This menu is suitable for scenarios where the scene is fixed and the person moves a small range of applications, such as classrooms. You need to pin a large scene, then push it up to the appropriate size to the detection area, and so on, until you overwrite all the areas you want to snap (the detected area that has been set up will be displayed on the video).

After adding cruising, the ball opportunity to set up the detection area, in turn cruise snap.

- (1) Adjust the scene to be caught on the face
- (2) "Number of detections" indicates the number of times a loop is required to detect all areas
- (3) "Detection Time" indicates the residence time of each detection area
- (4) The detection area list can set up to 48 zones.
- (5) The function face detection parameter configuration recommendation: The push chart strategy is the fastest, the number of snaps is 3 times

**Note:** In order to achieve the best detection effect, please install the camera and refer to the following conditions.

- (1) Please ensure the scene light is sufficient.
- (2) Face capture distance of 10 m if only the device's own white light is used at night.

## 5.14.2 Snapshot parameters

### Snapshot parameters -> Snapshot parameters

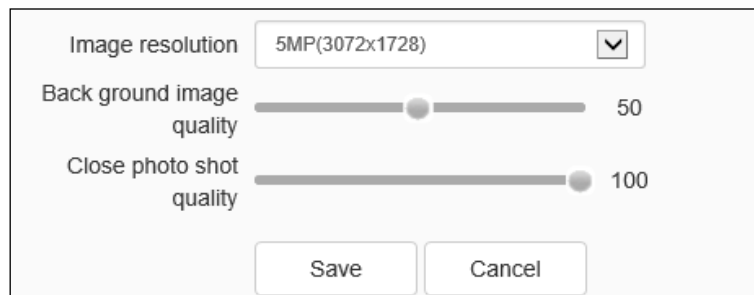

Fig.5.14.2.1 Snapshot parameters setting interface

Users set [Image Resolution], [JPEG quality] and [Image size limit (KB)] as needed.

[image resolution]: sets the image resolution, which supports 1440p, 1080p, 960p and other resolutions.

[JPEG quality]: set the quality of snapshots and support the quality of 0,100.

[image size limit (KB)]: set the size of snapped images. The maximum supported is 8192KB.

Click [save] to save the corresponding parameter settings.

Click [Cancel] to restore the last saved parameter.

### Snapshot parameters->Image superposition

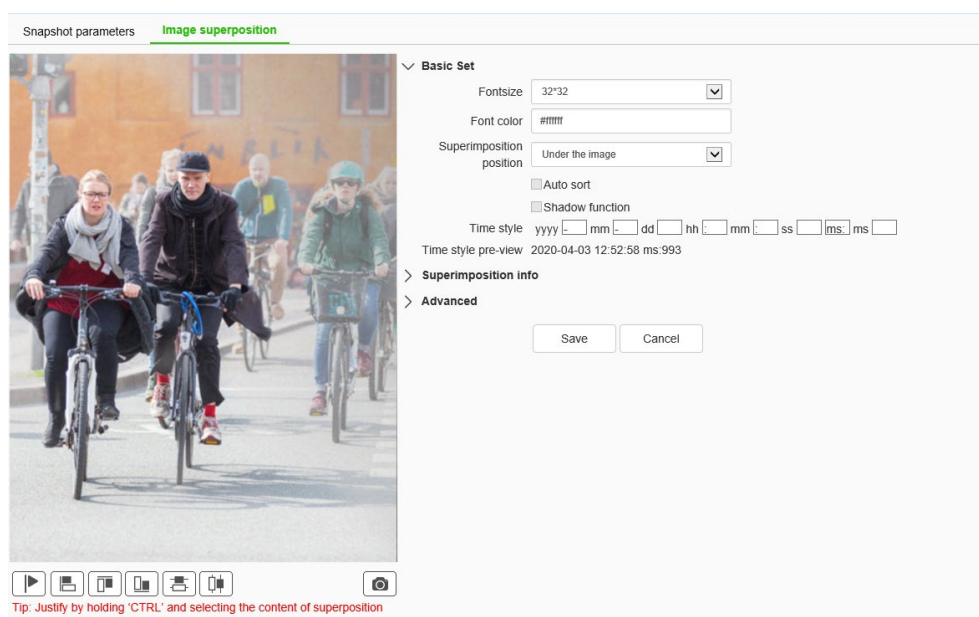

Snapshot parameters **Image superposition**

Basic Set

Fontsize: 32\*32

Font color: #ffff

Superimposition position: Under the image

Auto sort

Shadow function

Time style: yyyy-mm-dd hh:mm:ss.ms

Time style pre-view: 2020-04-03 12:52:58 ms:993

> Superimposition Info

> Advanced







Save Cancel

Tip: Justify by holding 'CTRL' and selecting the content of superposition



The user can set up Image Style as required. The equipment supports single image and composite image two styles. Under the camera synthesis style, you can enable / disable (keep the original style for single image).

The function description of the interface icon button is as follows:

Icon	Description
	Snapped Photo: Check the overlay effect for trial
	Default positions: Sets the storage location of snapshots for trial
	Left justified: Justify by holding 'CTRL' and selecting the content of superposition
	Top: Justify by holding 'CTRL' and selecting the content of superposition
	Bottom: Justify by holding 'CTRL' and selecting the content of superposition
	Horizontal Equidistance: Justify by holding 'CTRL' and selecting the content of superposition
	Vertical Equidistance: Justify by holding 'CTRL' and selecting the content of superposition

### **[Image superposition]=>[Basic Set]**

Users set parameter information such as [Fontsize], [Font color], [Superimposition position], [Time style] as needed.

[Fontsize]: 16\*16、24\*24、36\*36、48\*48 and 64\*64 are supported.

[Font color]: After clicking the text box, the color setting interface appears, select the appropriate color, click the circle button in the lower right corner to confirm and close the color setting interface.



[Superimposition position]: Support the mode of in the picture, above the picture under the picture.

[Auto sort]: Turns on / off the automatic sorting function, which is valid when the overlay position is "in the picture".

[Shadow function]: Sets the shadow effect, which is effective when the overlay position is "in the picture".

[Time style]: Set the time model. View the effect in the time style Preview below.

### **The function description of the interface icon button is as follows:**

Icon	Description
	Shift up: Select the overlay information and click this button to move the overlay information up one bit.
	Shift down: Select the overlay information and click this button to move the overlay information down one bit.

**Click [Save] to save the corresponding parameter settings.**

Click [Cancel] to restore the last saved parameter.

**[Image superposition]=>[Superimposition info]**

**The overlay information set by the user as needed. Multiple selection is supported for overlay information. Select [All] to select all overlay information.**

[Comment]: Modify according to the needs of users.

[Number of feed line characters]: Sets the maximum number of words per line.

[Number of starting spaces after line feed] Sets the position where the overlay content begins after the text wraps.

Click [Save] to save the corresponding parameter settings.

Click [Cancel] to restore the last saved parameter.

**[Image superposition]=>[Advanced]**

[Background image shows the position of target thumbnail]: Choose whether to overlay the background image in the picture to display the location of the target screenshot (shown when the face is captured).

Click [Save] to save the corresponding parameter settings.

Click [Cancel] to restore the last saved parameter.

### 5.14.3 Cruise Set

See 5.12.3 Cruise Set

## 5.14.4 Advance Params

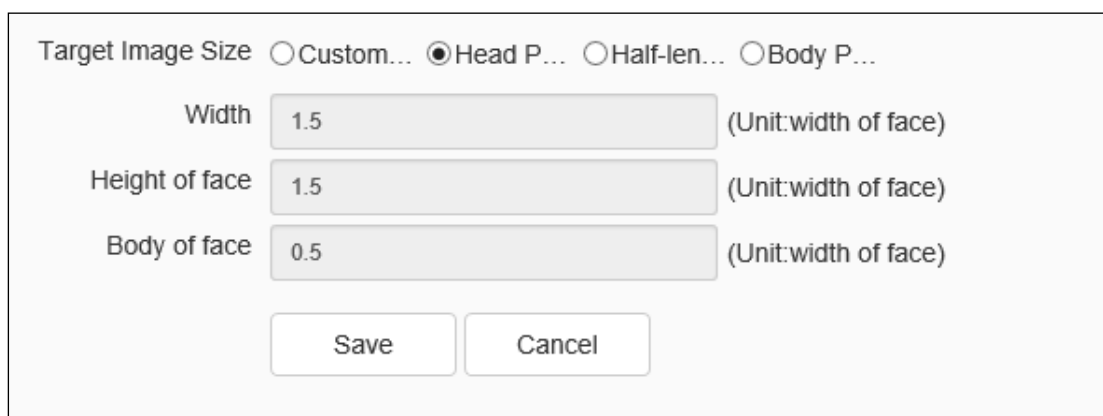

Target Image Size  Custom...  Head P...  Half-len...  Body P...

Width  (Unit:width of face)

Height of face  (Unit:width of face)

Body of face  (Unit:width of face)

Fig.5.14.4.1 Advance Params setting interface

Users can set the size of the target picture according to their needs, which can be divided into big head photos, bust photos, full-length photos and custom photos. When users choose to customize the size of the target picture, they can set the width of the picture, the height of the face part and the height of the body part.

Click [Save] to save the corresponding parameter settings.

Click [Cancel] to restore the last saved parameter.

## 5.15 Storage

### 5.15.1 Schedule Recording

**Schedule Recording -> Schedule Recording**

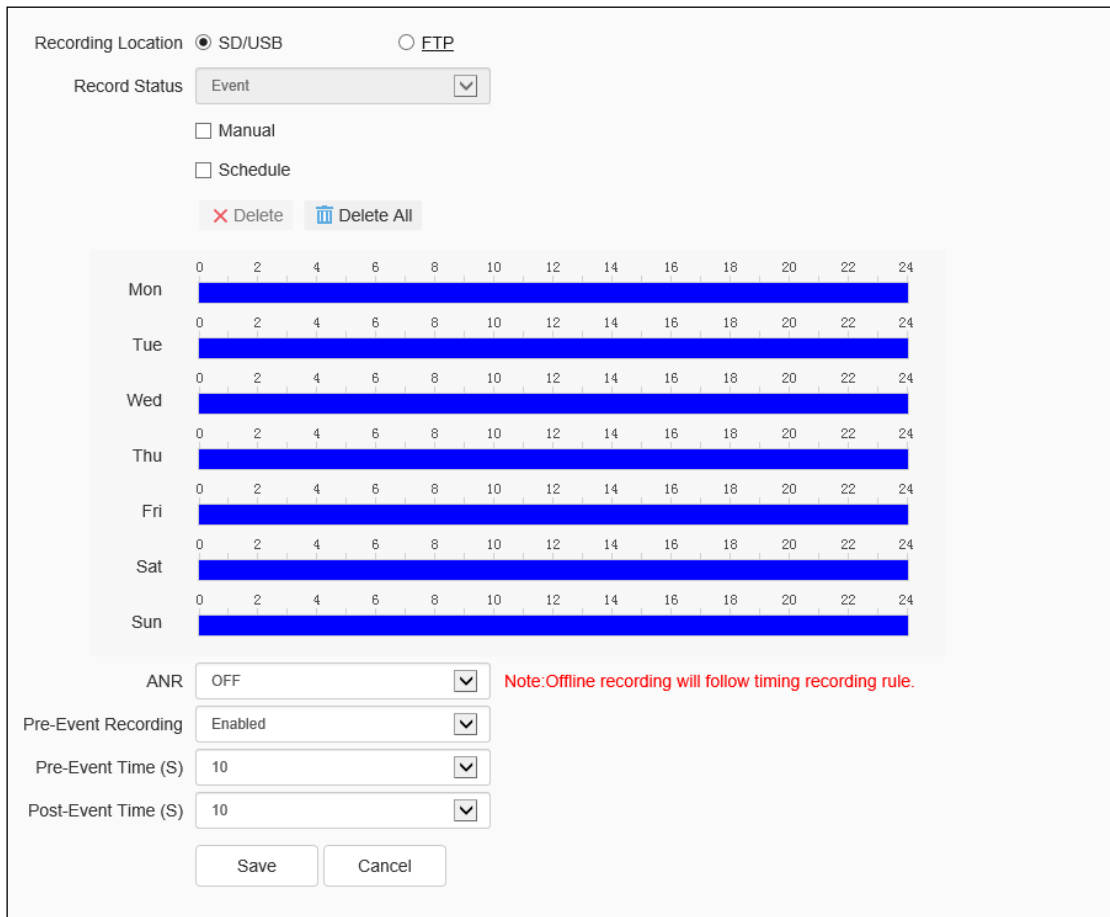

Recording Location  SD/USB  FTP

Record Status

Manual

Schedule

Day	0	2	4	6	8	10	12	14	16	18	20	22	24
Mon	[Blue bar]												
Tue	[Blue bar]												
Wed	[Blue bar]												
Thu	[Blue bar]												
Fri	[Blue bar]												
Sat	[Blue bar]												
Sun	[Blue bar]												

ANR  Note: Offline recording will follow timing recording rule.

Pre-Event Recording

Pre-Event Time (S)

Post-Event Time (S)

Fig.5.15.1.1 Schedule Recording setting interface

Switch the drop-down box to select the target video type, set the arming time, retention time (days), select the pre-recorded time, postpone the time.

[Record Status]: Show the device recording status.

[Record Beings]: Click to test beings switch to start recording and stop recording.

[Timed video recording]: It can set four time periods to perform timing video recording. Set the parameter of the conventional recording time period to the selected week.

[Offline Video Recording]: when the internet is disconnected, it will start timing recording into camera SD card .

Click the [Save] button to save the settings. Click the [Copy to...] button to copy the setting to other ports. Click [reset] will cause the parameters to be restored.

**Notes:** Offline Video Recording is only available on cameras with SD card, when turn on this function, schedule recording will be stopped.

## Schedule Recording->Packaging Mode

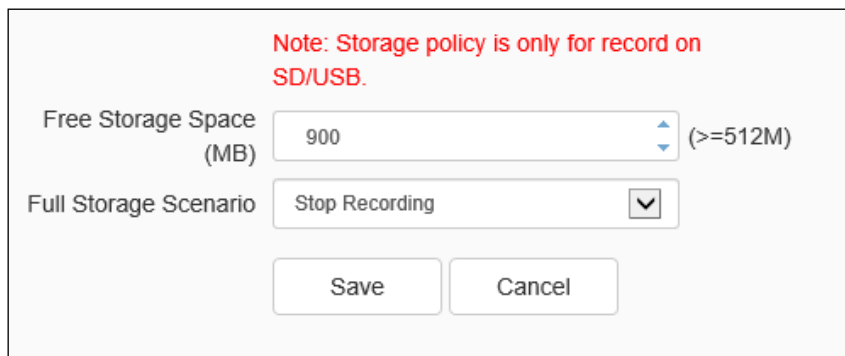

Note: Storage policy is only for record on SD/USB.

Free Storage Space (MB)  (>=512M)

Full Storage Scenario

Fig.5.15.1.2 Packaging Mode setting interface

The [Free Disk Space] can set the trigger conditions for storage in the edit box.

(1) Stop recording: stop the recording and packaging operation.

(2) Overwrite: Delete the earliest video files to create space for the latest recording.

(3) Overwrite: Delete the earliest video files (except for Alarm Rec) to create space for the newest recording. (The log file will not be deleted)

(4) Click [save] button to save the corresponding parameter settings. Click [reset] will cause the parameters to be restored.

## 5.15.2 Picture setting

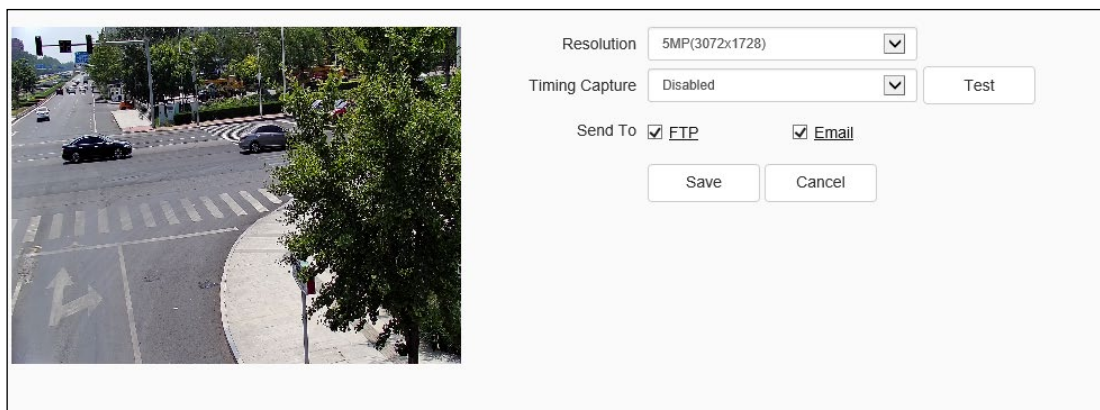

Resolution

Timing Capture

Send To  FTP  Email

Fig.5.15.2 Picture Setting interface

- (1) Set the interval time.
- (2) [interval]: Enter the time interval in the input box, switch the drop-down box to select the interval unit.
- (3) Chose [Linked FTP],capture the photos then upload to FTP.
- (4) Chose [Linked Email],sent it to designated email after capturing the photos.

[Test]: Test and snapshot a picture.

Click[Save]to keep record.

Click [Cancel]to recover data of last time.

### 5.15.3 Disk Management

<input type="checkbox"/>	Device	Total Space	Used Space	Free Space	State	Usage	Operation
<input type="checkbox"/>	SD1	27.50GB	1.00GB	26.50GB	Using	Record	

26.50GB/27.50GB(Residual Capacity/Total Capacity)

Fig.5.15.3 Disk Management

The interface can show the remaining capacity, total capacity of the current hard disk and virtual disk, as well as the disk use, with video, backup, redundancy and read-only four options

[initialize disk]:the list to select a particular piece of disk and then click the "initialize disk" button, the system pop-up whether initializes the disk, click the "ok" after the initialization of the disk for operation.

## 5.15.4 FTP

### FTP - > FTP

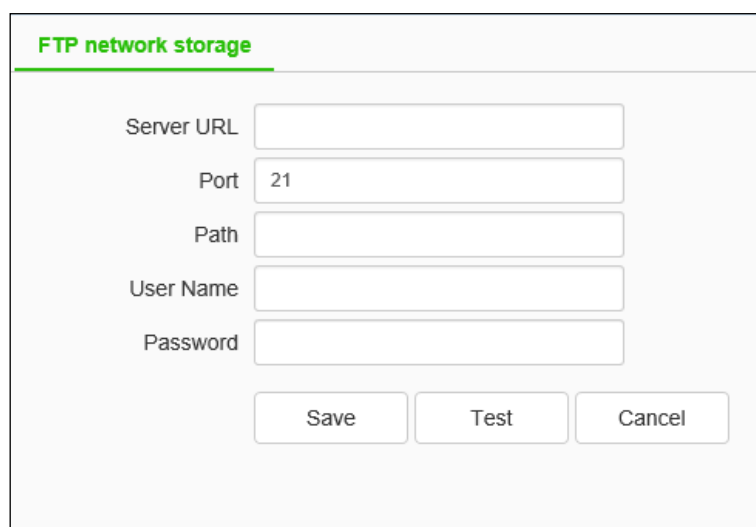

The screenshot shows a dialog box titled "FTP network storage" with a green header. It contains five input fields: "Server URL", "Port" (with the value "21" entered), "Path", "User Name", and "Password". At the bottom, there are three buttons: "Save", "Test", and "Cancel".

Fig.5.15.4.1 FTP setting interface

After changing [Server URL], [Port], [Path], [User Name] And [Password], [Save] can set the FTP server information. [Cancel] restore the last saved parameter.

[Test]: test whether the settings are correct and effective.



## FTP - >Face FTP

Enable FTP: Disabled

FTP Selection: FTP1

Basic Set

Data Type: Face data

Server URL: 0.0.0.0

Port: 21

User Name: admin

Password: \*\*\*\*

Password Confirm: \*\*\*\*

Upload background picture

Note: Enabling "Upload Background Map" requires opening the "Capture Background Map" function in intelligent analysis first.

Picture Name Setting

Picture Rename

Seperate: -

Naming Rules: Device IP, Snap Time, Gender

Directory Structure: Level 1 directory, Level 2 directory, Level 3 directory, Level 4 directory (all set to Empty)

Name Preview: [Empty]

Buttons: Save, Test, Cancel

Fig.5.15.4.2 Face FTP setting interface

Users set face-specific FTP according to their needs, such as [Data Type]、 [Server URL]、 [Directory Structure and so on.

[Enable FTP]: Three enable states are supported: do not enable, enable 1 FTP, and enable 2 FTP. When not enabled, the custom upload image name can be selected, and other interface contents are grayed out and cannot be modified; when 1 FTP is selected, the interface content becomes light, FTP selection is grayed out, and FTP1 is selected; when 2 FTP is enabled, all the interface content becomes light and the interface content can be modified.

[FTP Selection]: FTP1 and FTP2 are supported.

[Data Type]: Two data types of bayonet data and illegal data are supported.

[Server URL]: You need to enter an address in the form of IP.

[Port]: The port number is a numeric value between 1-65535.

[User Name]: 15 characters are accepted.

[Password]: Enter up to 15 characters.

[Password Confirm]: Enter the same content as the password, and when the input is different from the password, a check prompt box will pop up.

[Directory Structure]: Five directory structures are supported: root directory, first-level directory, second-level directory, third-level directory and fourth-level directory.







[Level 1 directory]: Toggle the drop-down box to select the directory option, which is the same as the contents of other directories.

[Picture Rename]: If Check it, settings of the picture will display .if not, the content of it will be hidden.

[Separate]: There is a default delimiter and manual modification is not supported.

[Naming Rules]: You can modify it manually to set a new naming rule.

[Name Preview]: Displays the content to the right of the naming.

Icon	Description
	Right shift all
	Right shift
	Left shift
	All left shift
	Shift up
	Shift down

[Save]: save the current settings.

[Test] Test whether the settings are correct and effective.

[Cancel]: restores the last saved parameter.

## 5.16 System

### 5.16.1 System

#### System - >Allocation of resources

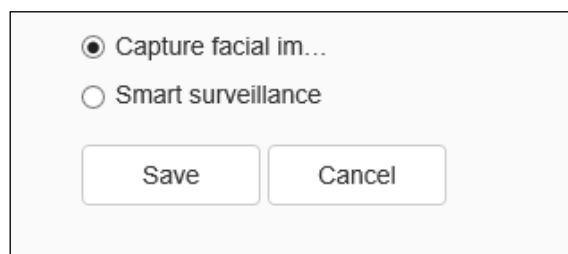

Fig.5.16.1.1 Allocation of resources interface

The user can modify the method of allocating resource, if the device supports Capture facial images, Face recognition, Smart surveillance.

[Capture facial images]: When the algorithm finds a person's face in the video, it captures the image and saves it to the preset location.

[Face Recognition]: When the camera finds a person's face in the video, it automatically queries and compares them from the face database.

[Smart surveillance]: Common monitoring mode includes intelligent algorithms such as behavior analysis, crowd gathering, video diagnosis and audio anomaly detection,etc.

## System - > Time

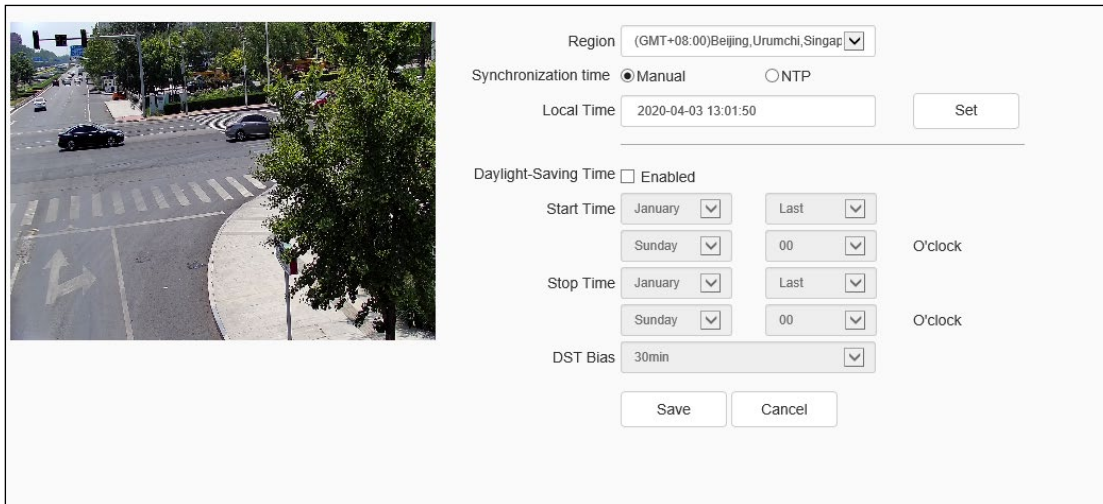

Region: (GMT+08:00)Beijing,Urumchi,Singap

Synchronization time:  Manual  NTP

Local Time: 2020-04-03 13:01:50 [Set]

Daylight-Saving Time:  Enabled

Start Time: January Last Sunday 00 O'clock

Stop Time: January Last Sunday 00 O'clock

DST Bias: 30min

[Save] [Cancel]

Fig.5.16.1.2 Time setting interface

Time zone: set the time zone information.

[Local Time]: real time display of local time.

[Synchronization Time]: the synchronization equipment time is the same as the local time.

[Daylight-Saving Time]: set whether daylight saving time is enabled. Set the time range and offset time for daylight saving time.

[NTP server]: enter the legal IP address of the server.

[Port]: enter the corresponding port number.

[Time Interval]: enter the interval of automatic time calibration.

[Test]: Test NTP automatic timing.

Click [save] to save the currently set parameters. Click[Cancel] to restore the last saved parameter.

## System - > Serial Port

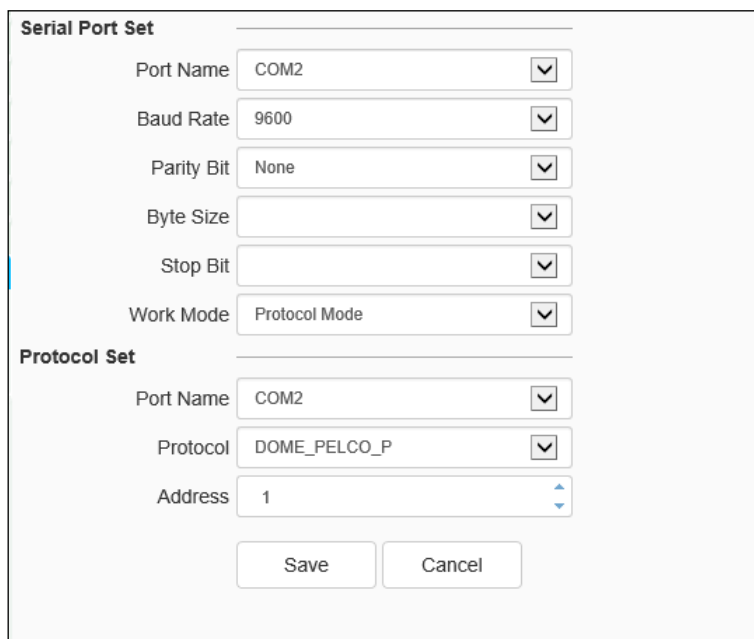

The image shows a configuration window titled "Serial Port Set" and "Protocol Set". The "Serial Port Set" section includes dropdown menus for Port Name (COM2), Baud Rate (9600), Parity Bit (None), Byte Size, Stop Bit, and Work Mode (Protocol Mode). The "Protocol Set" section includes dropdown menus for Port Name (COM2), Protocol (DOME\_PELCO\_P), and a spinner for Address (1). At the bottom are "Save" and "Cancel" buttons.

Fig.5.16.1.3 Serial port setting interface

Some models support serial port settings. It is divided into [serial port setting] and [protocol setting].

[Serial Port Set] requires the user to select [serial port number], [baud rate], [check bit], [data bit], [stop bit] and [working mode].

For [Protocol Set], you need to select [channel number], [serial port number], [protocol] and [address].

Note:

(1) Different models support different functions, please refer to actual product.

(2) When user set the peripherals, and [Save] all the setting, user can set [Temperature and humidity alarm] in [Event Management].

(3) Some models support setting baudrate.

## 5.16.2 Users

### Users->users

No.	User Name	Authority	Edit	Delete
1	Admin	Admin	<a href="#">Edit</a>	

Add

Fig.5.16.2.1 Users

Add ✕

User Name

Password

Password Strength Poor Mid Strong

Please generate 6-15 digits password with two or more combinations of numbers, lowercase, capital letter and special character.

Password Confirm

Authority  ▼

Fig.5.16.2.2 Add User

**Edit** ✕

User Name

Old Password

Password

Password Strength Poor Mid Strong

Please generate 6-15 digits password with two or more combinations of numbers, lowercase, capital letter and special character.

Password Confirm

Authority  ▼

Email

Optional (For Password Reset)

Fig.5.16.2.3 Modity password

[Add User]

The new user adds the user name, password, and permissions, where the user name and password can only be entered in English letters and Numbers. Click "save" button after the above three items are filled in.

**Notes:** Only the administrator can add and modify users.

[Modify password]

In the user list, click [edit] and then pop up the prompt box to change the password. Enter the old password, the new password and the password confirm and click the [modify] button.

[Delete User]

In the user list, click the [delete] button to pop up the prompt box to click ok.

## Users->Connection

Channel No.	Network Mode	Client IP	User Name
Channel No.1 1st Stream	TCP	192.168.15.216	Admin
Channel No.1 1st Stream	TCP	192.168.15.189	Admin

Fig.5.16.2.3 Connection interface

Displays a detailed list of connects/logins to the device, including channel type, network mode, client IP, and user name. Click [refresh] to update the list.

## 5.16.3 Maintenance

### Maintenance->Maintenance

**Device Control**

Basic Reset

Factory Reset

Reboot

Lens Reset

Close Telnet

**Configuration In/Out**

Files (\*.box)

Browse Import Export

Note: User need to manually input new IP to login again when IP address changed.

**Auto Maintenance**

Restart Time Never

Save



Fig.5.16.3.1 Maintenance interface

[Device Control]: allows customers to perform [restore default], [simple restore], [restore factory], [restart equipment], [aperture correction], [lens reset], [disable / enable ABF], [Open Telnet] and other operations. Because the functions of different models are different, please refer to the actual interface.

**[Import]/ [Export]:** used for equipment maintenance, mainly divided into three categories:

(1) [Event Server] options include alarm time period and linkage item setting information, excluding intelligent analysis.

(2) [Smart Analytics] options include settings related to intelligent analysis, including rules, time periods, etc.

(3) [System Setting] options include all setting information except the above alarm, intelligent analysis, logo, storage strategy and local setting, including video parameters, HD parameters, character superposition, video recording strategy, network setting and other information.

**[Auto maintenance]:** Set the automatic reboot time of the dome camera to conduct automatic maintenance.

**[Channel expansion]:** Change the number of channels supported by the device by changing the Number of Ways.(some equipment support)

## Maintenance - > Upgrade

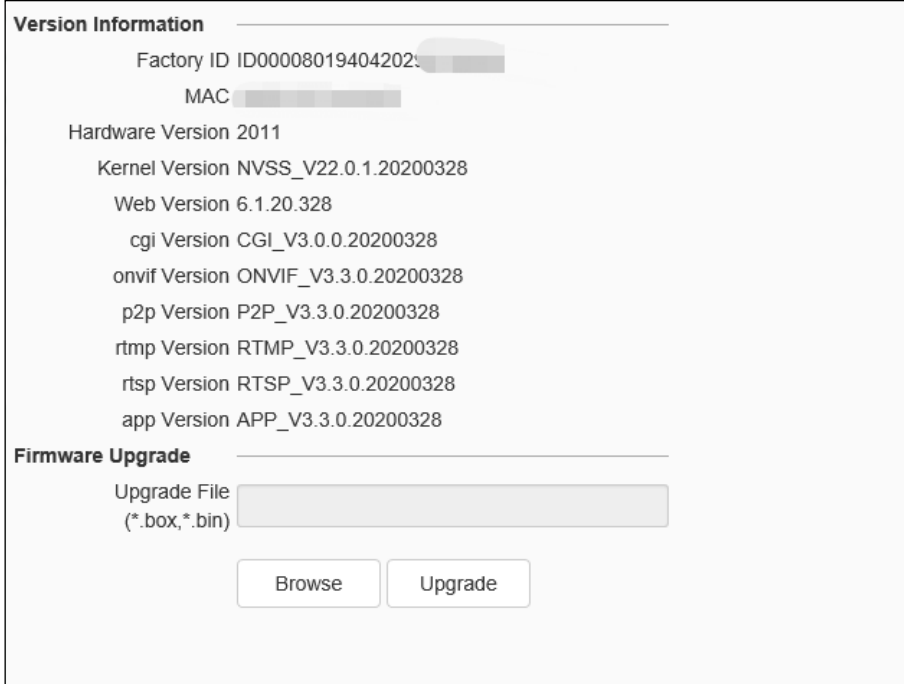

The screenshot displays a web interface for device maintenance. It is divided into two main sections: 'Version Information' and 'Firmware Upgrade'. The 'Version Information' section lists various system identifiers and versions, including Factory ID, MAC, Hardware Version, Kernel Version, Web Version, and several protocol versions (cgi, onvif, p2p, rtmp, rtsp, app). The 'Firmware Upgrade' section features a file selection field labeled 'Upgrade File (\* .box, \*.bin)', a 'Browse' button, and an 'Upgrade' button.

Version Information	
Factory ID	ID000080194042029
MAC	
Hardware Version	2011
Kernel Version	NVSS_V22.0.1.20200328
Web Version	6.1.20.328
cgi Version	CGI_V3.0.0.20200328
onvif Version	ONVIF_V3.3.0.20200328
p2p Version	P2P_V3.3.0.20200328
rtmp Version	RTMP_V3.3.0.20200328
rtsp Version	RTSP_V3.3.0.20200328
app Version	APP_V3.3.0.20200328

Firmware Upgrade	
Upgrade File (* .box, *.bin)	<input type="text"/>
<input type="button" value="Browse"/>	<input type="button" value="Upgrade"/>

Fig.5.16.3.2 Upgrade interface

### Upgrade - Version Information

[Version Information]: it includes equipment information such as [factory ID], [MAC], [Hardware Version],[ Kernel Version] and [Web Version].

### Upgrade - Firmware Upgrade

[Firmware Upgrade]: the user can select a local legal. Box or. Bin file to upgrade the device remotely. The upgrade operation of the kernel program shall be conducted under the guidance of the company's technical personnel.

[Browse]: find the upgrade file in the pop-up window.

[Upgrade]: upgrade to the latest version through the network.

## 5.16.4 Local PC Settings

Attention: Local routes are only valid in IE browser.

Record Videos	C:\Users\07378\NetVideoBrowser\RecordFiles\	Browse
Live Snapshots	C:\Users\07378\NetVideoBrowser\CapturePics\	Browse
Playback Snapshots	C:\Users\07378\NetVideoBrowser\PlaybackPics\	Browse
Video Clips	C:\Users\07378\NetVideoBrowser\PlaybackFiles\	Browse
Downloaded Files	C:\Users\07378\NetVideoBrowser\DownloadFiles\	Browse
Face Capture	C:\Users\07378\NetVideoBrowser\FacePics\	Browse

Protocol Type: TCP

Local Capture Format: JPG

Enable GPU acceleration will take effect after reconnect the video.

Save Cancel

Fig.5.16.4Local PC Settings

[Video File / Preview Capture / Playback Capture / Playback Clip / Playback Download / Smart Analysis Path / Face Capture / Traffic Capture]: You can set the storage path.(Please refer to the actual interface display)

[Protocol Type]: User can choose the network connection protocol for the camera. (When [Protocol Type] is [UDP], only one connection is supported.)

In the pull-down list of [Local Capture Format], select the picture format of the local snapshot. Such as [JPG], [BMP], etc. If send pic to FTP or Email, please select JPG.

[Enable GPU Acceleration]: After users select, camera enable GPU acceleration.

### Notes:

If the video preview is bad or the system crashes, you need to disable the GPU acceleration, because the PC hardware driver does not match.

# 6 Simple Troubleshooting

Fault Description	Possible reason	Troubleshooting method
No action, image or self-checking when powered on	Power supply is damaged or insufficient	Change the power supply
	Wrong power-line connection	Amend, pay attention to the positive and negative side of DC power supply
	Wiring problem	troubleshoot the circuit and measure the terminal voltage of the dome camera
self-checking normal	Wiring problem, damaged network cable or switch	PC connects to the dome camera directly to determine the problem segment
	The equipment is not in the same network segment as PC	Troubleshoot the line, modify the IP address to ensure that the IP does not conflict with each other
cannot login	User name or password error	check the current login user name and password of the dome camera
	Port number error	Check the port number of current dome camera
	Set up blacklist and whitelist	Hard reset
	Login account exceeds the limit	Disconnect other users
Normal login, unable to connect video	User-end connection exceeds equipment limit	excessive proxy of front-end video
	Camera abnormal	Check daily record of the equipment
	Parameter configuration error	Dome camera restores default parameters
Fig.patchy	IP conflict, MAC conflict, broadcast storm	Troubleshoot circuit and network settings, capture packet, troubleshoot with direct connection
	circuit problem, network line virtual connection	toubleshoot circuit
Video break,jam, or delay	PC insufficient performance	Check CPU usage rate, reduce bitstream and resolution
	Low frame rate setting, video breaking	Adjust the frame rate to more than 20 frames
	Lack of bandwidth	Sustitute for Gigabit switch

	Insufficient performance of back-end decoding equipment	Substitute for high-performance NVR, decoder and other decoding equipment.
cannot control the dome camera	Serial port setting error	Front-end dome camera serial port shall be COM2
	Baud rate, protocol or address error	Adjust control parameters of control end
Automatic restart the dome camera repeatedly	Insufficient power supply and unstable voltage	Measure the voltage of the dome camera terminal to ensure the power supply voltage stable
	PPPOE dialing failed	Dial parameters are set correctly, modify parameters
	The camera has no Fig. The dome camera is restarted	Camera damaged, replace camera
	Parameter setting abnormal	Restore default parameters
cannot recognize TF card	Plug and unplug the TF card under power lost condition	Reinsert after power lost
		Reformat
	Card loosening	Reseat the TF card
Audio fault	Confirm that the driver and wiring of the corresponding sound card of the host are correct, and play music to test	Install audio driver
	Make sure that "audio and video streaming" is selected, not "video streaming"	Set as "audio and video" in audio and video parameters
	wiring are correct	Re-wiring
	Adjust the audio input volume through IE, maybe it is too low	Re-set the volume

# 7 After-sales Services

For the high-definition network series camera produced in our company, we promise one-year warranty. During the product warranty period, the company provides free maintenance services, but in case of the following circumstances, the material cost and labor cost shall be charged as appropriate:

- (3) The camera is damaged due to the operation not in accordance with the user manual;
- (4) Lightning, fire and irresistible natural disasters;
- (5) Damage caused by matching problems due to poor product design of other manufacturers;
- (6) Due to our continuous adoption of new technology, product parameters are subject to change without notice.

# 8 Appendix I Lightning Protection and Surge Protection

Lightning and surge protection shall be considered for outdoor cameras. On the premise of ensuring electrical safety, the following lightning protection measures can be taken:

- 1) The signal transmission line must be kept at least 50 meters away from the high-voltage equipment or high-voltage cable;
- 2) Outdoor wiring shall be routed under the eaves as much as possible;
- 3) For the open area, the sealed steel pipe must be buried for wiring, and the steel pipe shall be grounded at one point, and the overhead wiring is absolutely prohibited;
- 4) In strong thunderstorm area or high induced voltage area (such as high-voltage substation), additional high-power lightning protection equipment and lightning rod must be installed;
- 5) The lightning protection and grounding design of outdoor devices and lines must be considered in combination with the lightning protection requirements of buildings, and meet the requirements of relevant national standards and industry standards;
- 6) The system must be equipotential grounded. The grounding device must meet the double requirements of system anti-interference and electrical safety, and shall not be short circuited or mixed connected with the zero line of the strong current network.

When the system is grounded separately, the grounding impedance shall not be greater than  $4 \Omega$ , and the cross-sectional area of the grounding conductor shall not be less than

25mm<sup>2</sup>.

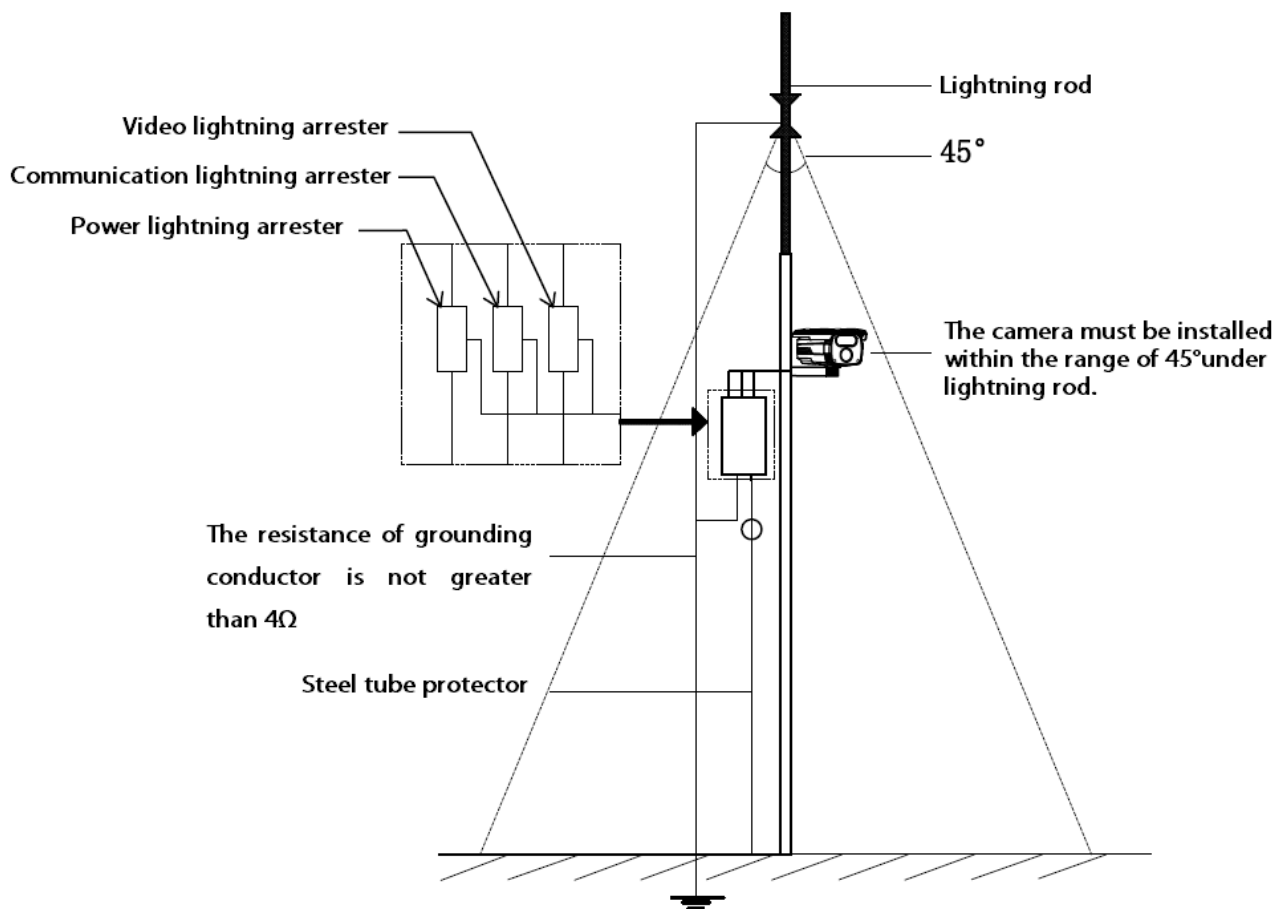



**DS1099-117**

**URMET S.p.A.**  
10154 TORINO (ITALY)  
VIA BOLOGNA 188/C  
Tel. +39 011.24.00.000 (RIC.AUT.)  
Fax +39 011.24.00.300 - 323

**urmet**



Area tecnica  
servizio clienti +39 011.23.39.810  
[www.urmet.com](http://www.urmet.com)  
e-mail: [info@urmet.com](mailto:info@urmet.com)  
MADE IN CHINA